

## HOLDER DETAILS

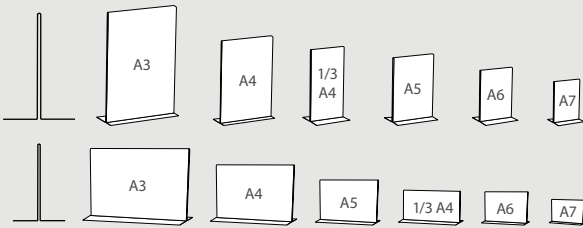

## DIMENSIONS



## INFORMATION

This acrylic sign holder features an inverted "T" shape with portrait or landscape and 6 sizes for each orientation. Our sign holder is designed to hold two standard high sheets of paper back-to-back for double-sided viewing. Paper slips in easily through the bottom and sides. Ideal as marketing tool for a whole range of businesses. Schools, hospitals, real estate offices, coffee menus and retail stores.

*T" OPEN	PORTRAIT	THICKNESS				
13.069P	A3	2mm	x6 			
13.027P	A4	2mm	x10 			
13.028P	A5	2mm	x10 			
13.068P	A6	2mm	x10 			
13.147P	A7	2mm	x10 			
13.148P	1/3 A4	2mm	x10 			

*T" OPEN	LANDSCAPE	THICKNESS				
13.069L	A3	2mm	x6 			
13.027L	A4	2mm	x10 			
13.028L	A5	2mm	x10 			
13.068L	A6	2mm	x10 			
13.147L	A7	2mm	x10 			
13.148L	1/3 A4	2mm	x10 			

## "T" OPEN SIGN HOLDER



HOLDER DETAILS



INFORMATION

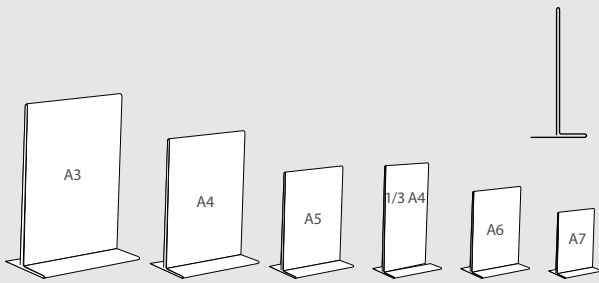

INFORMATION

This closed acrylic sign holder features an inverted "T" shape with 6 sizes available. Our sign holder is designed to hold two standard high sheets of paper back-to-back for double-sided viewing. Paper slips go in easily through the sides.

"T" CLOSED SIGN HOLDER







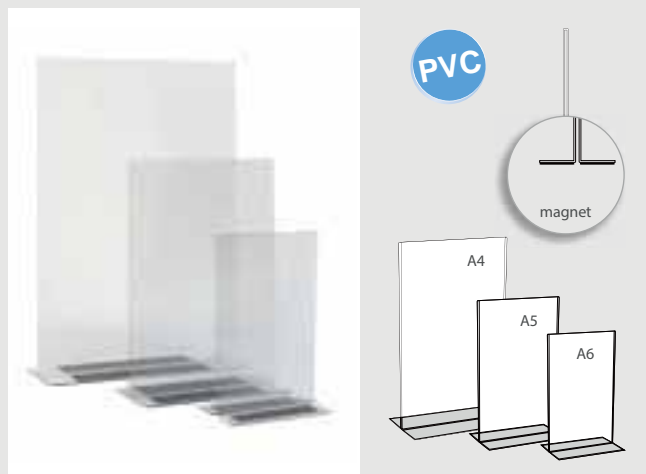





"T" CLOSED	PORTRAIT	THICKNESS			
13.000	A3	3mm	x6 		
13.001	A4	2mm	x10 		
13.002	A5	2mm	x10 		
13.003	A6	2mm	x10 		
13.350	A7	2mm	x10 		
13.351	1/3 A4	2mm	x10 		

## HOLDER DETAILS



## INFORMATION

This open display is made of PVC and it features an inverted portrait "T" shape with 3 sizes. Also, it has 2 magnetic strips to fix it over metallic surfaces. This is ideal as marketing tool for a whole range of businesses.

"T" MAGNET	PORTRAIT	THICKNESS			
13.046	A4	0.7mm	x10 	  	
13.047	A5	0.7mm	x10 	  	
13.048	A6	0.7mm	x10 	  	

## "T" MAGNET PVC HOLDER



## HOLDER DETAILS

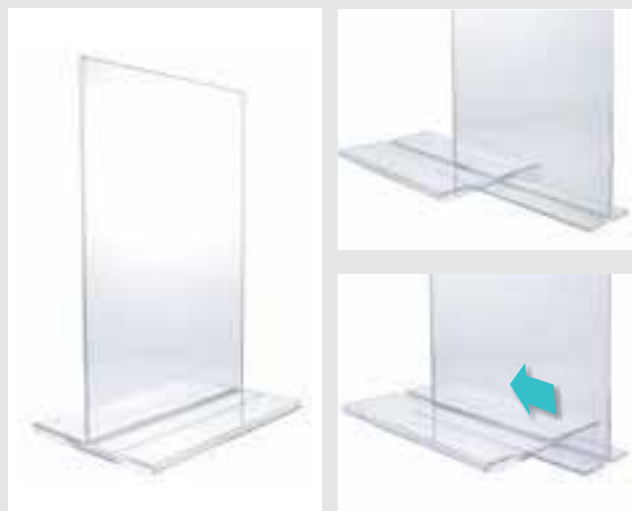

## INFORMATION

This closed transparent Sign Holder has portrait orientation and it features an removable base, which you can take it off to get an easy change of the graphic.

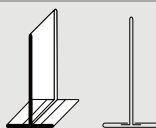

REMOVABLE	FORMAT	THICKNESS			
13.018	A4	2mm	x10 	 	
13.019	A5	2mm	x10 	 	

## REMOVABLE BASE HOLDER









HOLDER DETAILS



acrylic

INFORMATION

This magnetic display is made of Acrylic and it features an inverted portrait "T" shape with 3 sizes. Also, it has 2 magnetic strips to fix it over metallic surfaces. This is ideal as marketing tool for a whole range of businesses.

"T" MAGNET	PORTRAIT	THICKNESS			
13.841-1	A4	3mm	x5		
13.841-2	A5	3mm	x5		
13.841-3	A6	3mm	x5		

"T" MAGNET HOLDER



HOLDER DETAILS



acrylic

INFORMATION

This display is made two pieces of 8mm acrylic with four magnets at corners for easy change of graphics. Can be used in portrait or landscape orientation, but landscape mode presents better stability.

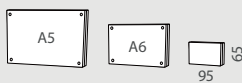

BLOCK MAGNET	PORTRAIT	THICKNESS			
13.843-1	A5	8mm	x6		
13.843-2	A6	8mm	x6		
13.843-3	95x65	8mm	x10		

ACRYLIC MAGNETIC BLOCK



HOLDER DETAILS



DIMENSIONS

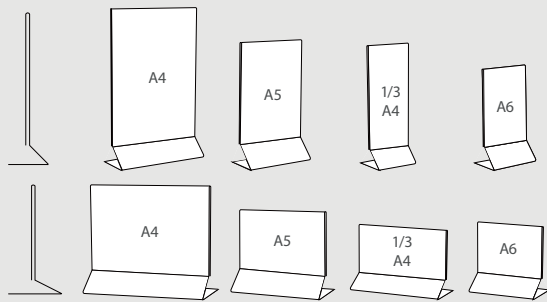

INFORMATION

This acrylic sign holder features a "Z" shape with portrait or landscape and 4 sizes for each orientation. Our sign holder is designed to hold two standard high sheets of paper back-to-back for double-sided viewing. Paper slips in easily through the bottom and sides. Ideal as marketing tool for a whole range of businesses. Schools, hospitals, real estate offices, coffee menus and retail stores.

*Z* OPEN	PORTRAIT	THICKNESS				
13.008P	A4	2mm	x10			
13.009P	A5	2mm	x10			
13.010P	A6	2mm	x10			
13.363P	1/3 A4	2mm	x10			

*Z* OPEN	LANDSCAPE	THICKNESS				
13.008L	A4	2mm	x10			
13.009L	A5	2mm	x10			
13.010L	A6	2mm	x10			
13.363L	1/3 A4	2mm	x10			

"Z" OPEN SIGN HOLDER

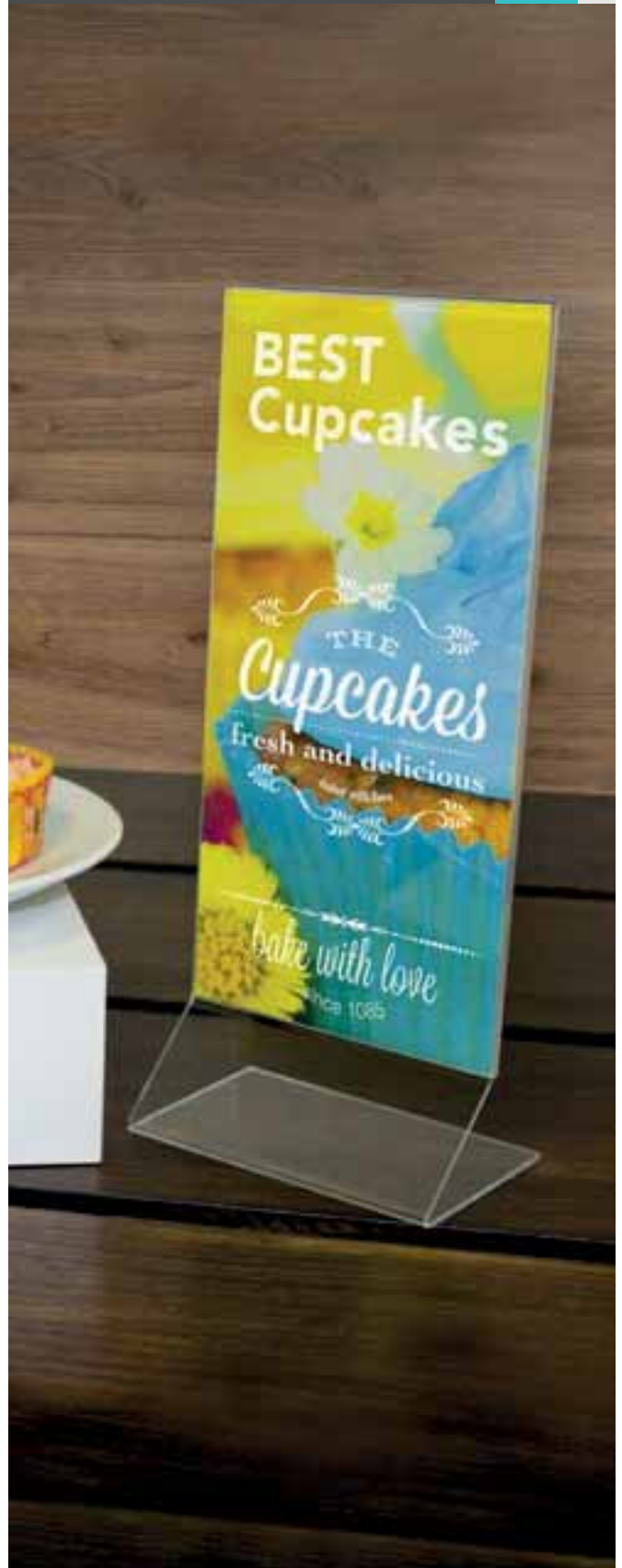

## HOLDER DETAILS



## DIMENSIONS

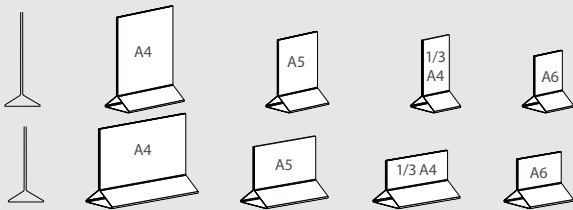

## INFORMATION

This closed Menu Sign Holder with "Snake" shape has landscape and portrait orientation. 4 sizes of each are available. Paper slips in easily through the sides. It is ideal for schools, hospitals, real estate offices, coffee menus or retail stores.

"SNAKE"	PORTRAIT	Thickness				
13.364P	A4	2mm	x10			
13.365P	A5	2mm	x10			
13.366P	A6	2mm	x10			
13.367P	1/3 A4	2mm	x10			

"SNAKE"	LANDSCAPE	Thickness				
13.364L	A4	2mm	x10			
13.365L	A5	2mm	x10			
13.366L	A6	2mm	x10			
13.367L	1/3 A4	2mm	x10			

## "SNAKE" SIGN HOLDER



## HOLDER DETAILS





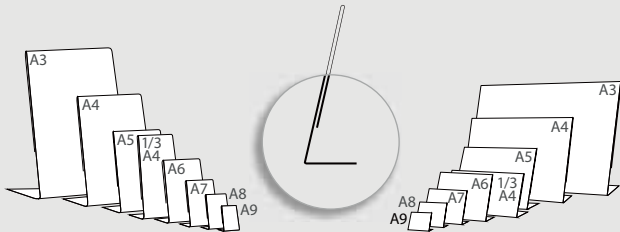





















## DIMENSIONS



## INFORMATION

This acrylic sign holder features an "L" shape with portrait or landscape and 8 sizes for each orientation. Our sign holder is designed to hold two standard high sheets of paper back-to-back for double-sided viewing. Paper slips in easily through the bottom and sides. Ideal as marketing tool for a whole range of businesses. Schools, hospitals, real estate offices, coffee menus and retail stores.

"L" SHAPE	PORTRAIT	THICKNESS				
13.004P	A3	3mm	x5 			
13.005P	A4	2mm	x10 			
13.006P	A5	2mm	x10 			
13.007P	A6	2mm	x10 			
13.352P	A7	2mm	x10 			
13.353P	A8	2mm	x20 			
13.354P	A9	2mm	x20 			
13.355P	1/3 A4	2mm	x10 			

"L" SHAPE	LANDSCAPE	THICKNESS				
13.004L	A3	3mm	x5 			
13.005L	A4	2mm	x10 			
13.006L	A5	2mm	x10 			
13.007L	A6	2mm	x10 			
13.352L	A7	2mm	x10 			
13.353L	A8	2mm	x20 			
13.354L	A9	2mm	x20 			
13.355L	1/3 A4	2mm	x10 			

## "L" CLOSED SIGN HOLDER



## HOLDER DETAILS



## INFORMATION

This open display is made of PVC and it features an "L" shape and 5 sizes with portrait orientation. Ideal as marketing tool for a whole range of businesses such as schools, hospitals, real estates offices, coffee menus or retail stores.

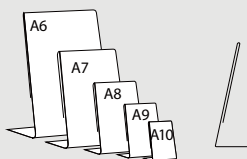

"L" PVC	PORTRAIT	THICKNESS			
13.356P	A6	0.4mm	x50		
13.357P	A7	0.4mm	x50		
13.358P	A8	0.4mm	x50		
13.359P	A9	0.4mm	x50		
13.360P	A10	0.4mm	x50		

## "L" PVC SIGN HOLDER



## INFORMATION

This open display is made of PVC and it features an "L" shape and 5 sizes with portrait orientation. Ideal as marketing tool for a whole range of businesses such as schools, hospitals, real estates offices, coffee menus or retail stores.



"L" PVC	LANDSCAPE	THICKNESS			
13.356L	A6	0.4mm	x50		
13.357L	A7	0.4mm	x50		
13.358L	A8	0.4mm	x50		
13.359L	A9	0.4mm	x50		
13.360L	A10	0.4mm	x50		

## HOLDER DETAILS

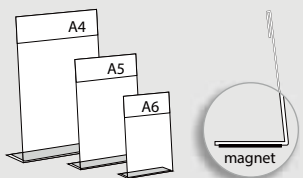

## INFORMATION

This open display is made of PVC and it features an "L" shape with 3 sizes. Also, it has 2 magnetic strips to fix it over metallic surfaces. Ideal as marketing tool.

"L" MAGNET	PORTRAIT	THICKNESS			
13.049	A4	0.7mm	x10		
13.050	A5	0.7mm	x10		
13.051	A6	0.7mm	x10		

## "L" MAGNET PVC HOLDER



HOLDER DETAILS



DIMENSIONS

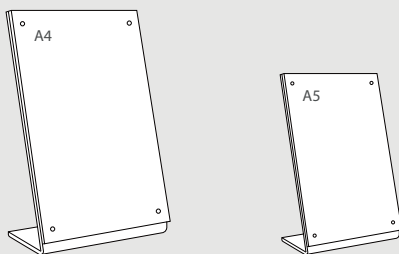

INFORMATION

This acrylic sign holder features an "L" shape with portrait orientation and 2 sizes available. This sign holder features a sandwich with two pieces of 4mm acrylic and 4 magnets at corners for easy change of graphics. Ideal as marketing tool for a whole range of businesses like Schools, hospitals, real estate offices, banks, coffee menus and retail stores.

"L" MAGNET	PORTRAIT	THICKNESS		
13.842-1	A4	4mm	x5 	 
13.842-2	A5	4mm	x5 	 

"L" MAGNETIC HOLDER



HOLDER DETAILS



DIMENSIONS

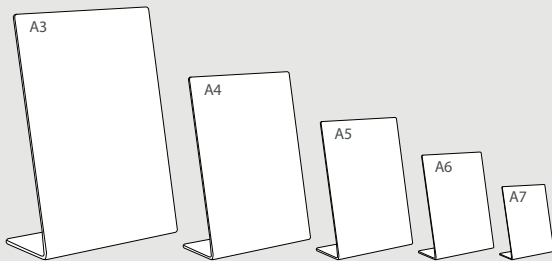

INFORMATION

This elegant display features an "L" shape with portrait orientation and 5 sizes available. This sign holder is made of 3mm black acrylic with the front face in matt finish and the back in gloss finish. Possibility of sticking a graphic on the front face. Ideal as marketing tool for a whole range of businesses like Schools, hospitals, real estate offices, banks, coffee menus and retail stores.

"L" BLACK	PORTRAIT	THICKNESS			
13.844-1	A3	3mm	x5 		
13.844-2	A4	3mm	x10 		
13.844-3	A5	3mm	x10 		
13.844-4	A6	3mm	x10 		
13.844-5	A7	3mm	x10 		

"L" BLACK HOLDER

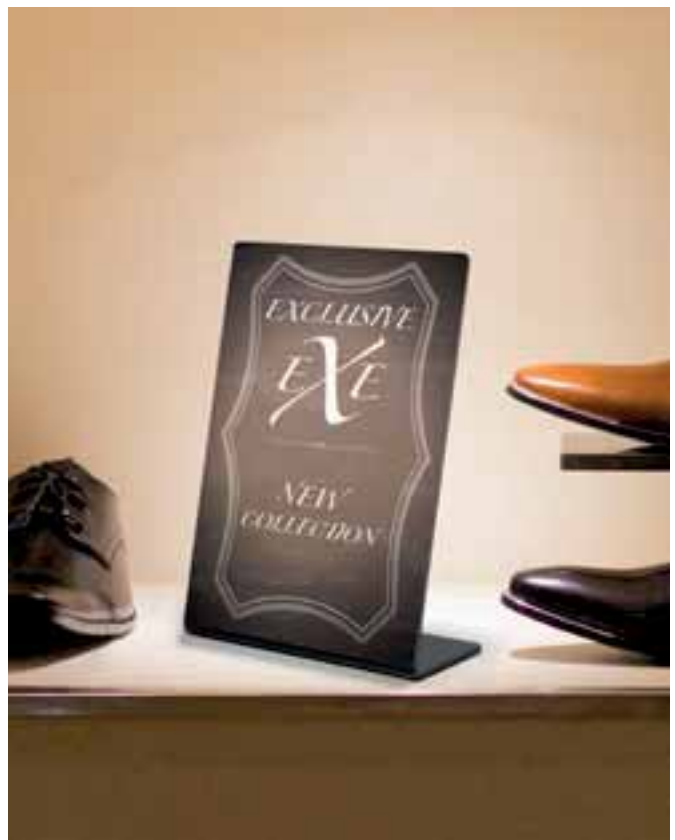

## HOLDER DETAILS



## DIMENSIONS

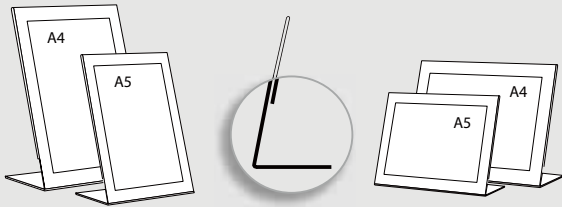

## INFORMATION

This acrylic sign holder features an "L" shape with portrait or landscape and 2 sizes for each orientation. This Sign Holder features a black frame for a stylish finish and it is designed to hold two standard high sheets of paper back-to-back for double-sided viewing. Paper slips in easily through the bottom and sides. Ideal as marketing tool for a whole range of businesses. Schools, hospitals, real estate offices, banks, coffee menus and retail stores.

BLACK FRAME	PORTRAIT	THICKNESS			
13.361P	A4	2mm	x5 		
13.362P	A5	2mm	x5 		

BLACK FRAME	LANDSCAPE	THICKNESS			
13.361L	A4	2mm	x5 		
13.362L	A5	2mm	x5 		

## "L" BLACK FRAME HOLDER



## HOLDER DETAILS



## DIMENSIONS

\*mm

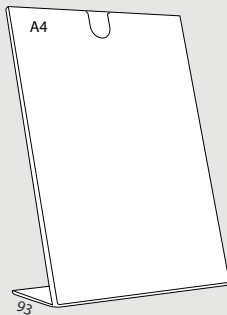

## INFORMATION

This display features an "L" shape with portrait orientation for A4 size documents. This sign holder is made of transparent polystyrene with top loading graphic change. Ideal as marketing tool for a whole range of businesses like Schools, hospitals, real estate offices, banks, coffee menus and retail stores.

## "L" HOLDER WITH OPENING new



"L" MAGNET    PORTRAIT    THICKNESS

13.835

A4

2mm

x5



HOLDER DETAILS

\*mm

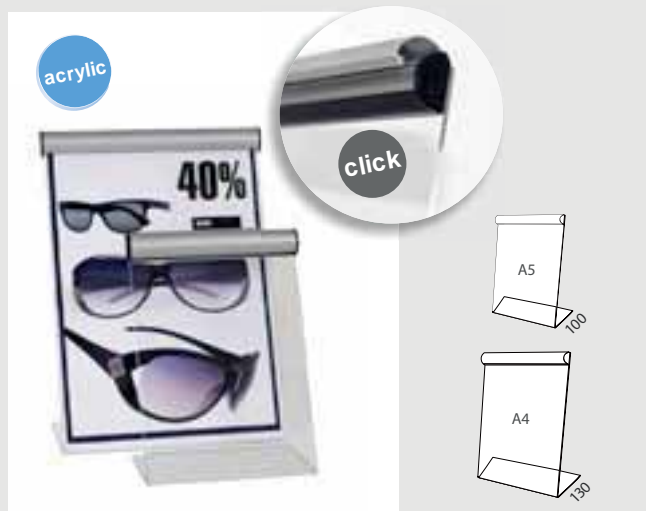

INFORMATION

This closed Sign Holder has an "L" shape and it features a snap top holder to fix the graphics. 2 portrait sizes available. This display is ideal for placing in hotels, schools, and lobby entrance ways for a unique and attention grabbing presentation.

"L" SNAP	PORTRAIT	THICKNESS			
13.384	A4	2mm	x5		
13.385	A5	2mm	x5		

"L" SNAP SIGN HOLDER



HOLDER DETAILS

\*mm

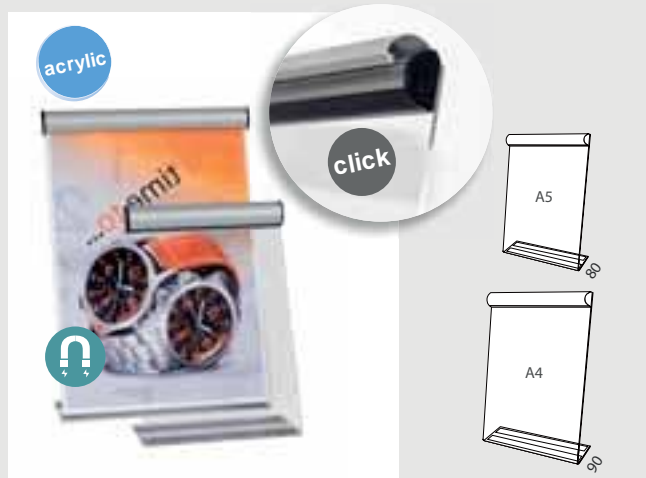

INFORMATION

This closed Sign Holder features an "L" shape and 2 sizes for documents with portrait orientation with a click system to fix the graphics. Two magnetic strips at the base included so it is ideal for placing on shelves or metallic structures at stores for a unique and attention grabbing presentation.

"L" SNAP	PORTRAIT	THICKNESS			
13.016	A4	2mm	x5		
13.017	A5	2mm	x5		

"L" SNAP MAGNET HOLDER



## HOLDER DETAILS



## DIMENSIONS

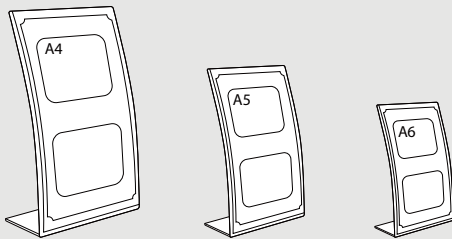

## INFORMATION

This elegant display features an "L" shape with portrait orientation and 3 available sizes. This sign holder is made from strong plastic and is available with white surround. Comes with a non-reflective cover sheet. Ideal as marketing tool for a whole range of businesses like Schools, hospitals, real estate offices, banks, coffee menus and retail stores.

"L" CURVED	PORTRAIT	THICKNESS			
13.840-1	A4	3mm	x10 		
13.840-2	A5	3mm	x10 		
13.840-3	A6	3mm	x10 		

## "L" CURVED HOLDER

**new**



### HOLDER DETAILS



### "L" + BROCHURE HOLDER



### DIMENSIONS

\*mm

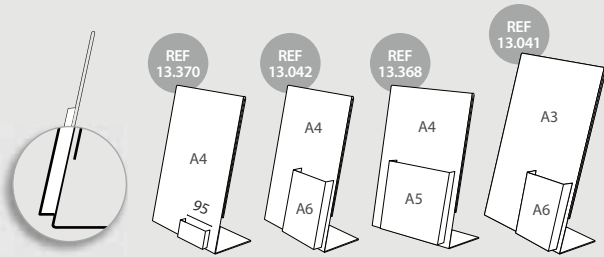

### INFORMATION

This Closed Holder Display features an "L" shape for A4 or A3 format documents with portrait orientation. It features a brochure holders for showcards. Paper slips in easily through the sides. Ideal as marketing tool for a whole range of businesses. Schools, hospitals, real estate offices, banks, coffee menus and retail stores.

"L" DISPLAY	SIZE	THICKNESS		*mm
13.370	A4 + Showcard	2 (leaflet 2)	x5	
13.042	A4 + A6 Leaflet	3 (leaflet 2)	x5	
13.368	A4 + A5 Leaflet	2 (leaflet 2)	x5	
13.041	A3 + A6 Leaflet	3 (leaflet 2)	x5	

## HOLDER DETAILS

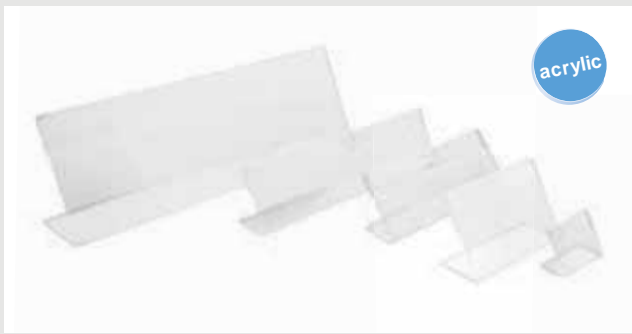

## INFORMATION

\* mm

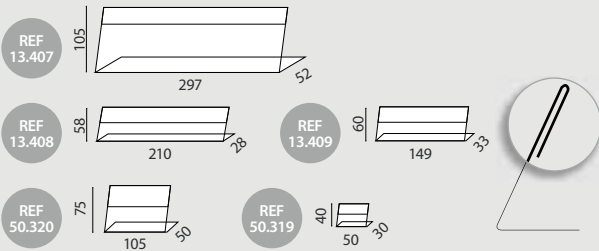

This Desktop Sign Holder has a "L" shape and it is made of 2mm thickness acrylic. 5 sizes available with landscape orientation. Paper slips in easily through the sides.

DESK	SIZE	THICKNESS				
13.407	297x105x52mm	2mm	x10			
13.408	210x58x28mm	2mm	x20			
13.409	149x60x33mm	2mm	x20			
50.320	105x75x50mm	2mm	x20			
50.319	50x40x30mm	2mm	x20			

## DESK ACRYLIC SIGN



## HOLDER DETAILS



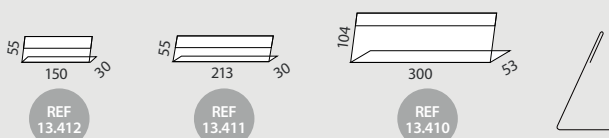

## INFORMATION

\* mm



This transparent Desk Sign is made of 0.5mm thickness PVC, featuring 3 models available. It is ideal for displaying ID cards, directory signage or temporary notes.

DESK PVC SIGN	SIZE	THICKNESS			
13.410	300x104x53mm	0.5mm	x20		
13.411	213x55x30mm	0.5mm	x20		
13.412	150x55x30mm	0.5mm	x20		

## DESK PVC SIGN



## HOLDER DETAILS



## INFORMATION

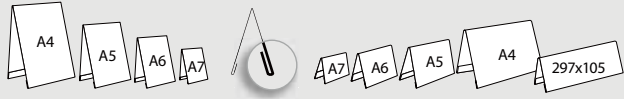

This Sign Holder Display is made of acrylic and has a tent portrait or landscape shape for double-sided viewing. Available in 4 sizes. Paper inserts in easily through the sides.

TENT	SIZE	THICKNESS			
13.029P	A4	2mm	x10		
13.030P	A5	2mm	x10		
13.031P	A6	2mm	x10		
13.032P	A7	2mm	x10		
"L" PVC	LANDSCAPE	THICKNESS			
13.029L	A4	2mm	x10		
13.030L	A5	2mm	x10		
13.031L	A6	2mm	x10		
13.032L	A7	2mm	x10		
13.033L	297x105mm	2mm	x10		

## TENT ACRYLIC DISPLAY



## HOLDER DETAILS



## INFORMATION



This Sign Holder Display is made of PVC and has a tent portrait or landscape shape for double-sided viewing. Available in 4 sizes. Paper inserts in easily through the sides.

TENT PVC	SIZE	THICKNESS			
13.415P	A6	0.4mm	x50		
13.416P	A7	0.4mm	x50		
13.417P	A8	0.4mm	x50		
13.418P	A9	0.4mm	x50		
13.419P	A10	0.4mm	x50		
"L" PVC	LANDSCAPE	THICKNESS			
13.415L	A6	0.4mm	x50		
13.416L	A7	0.4mm	x50		
13.417L	A8	0.4mm	x50		
13.418L	A9	0.4mm	x50		
13.419L	A10	0.4mm	x50		

## TENT PVC DISPLAY



## HOLDER DETAILS



## INFORMATION

\*mm

This acrylic sign Holder with stylish rectangular wooden base is available in 3 sizes (A4, A5 and A6). It is designed for portrait orientation of graphics.

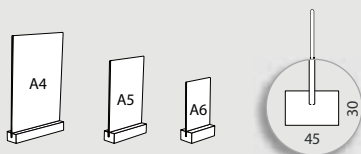

WOOD BASE PORTRAIT THICKNESS

WOOD BASE	PORTRAIT	THICKNESS			
13.011P	A4	2mm	x10	↑	↺
13.012P	A5	2mm	x10	↑	↺
13.013P	A6	2mm	x10	↑	↺

## WOOD BASE HOLDER



## INFORMATION

\*mm

This acrylic sign Holder with stylish rectangular wooden base is available in 3 sizes (A4, A5 and A6). It is designed for portrait orientation of graphics.

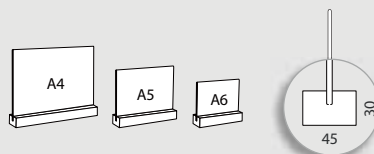

WOOD BASE LANDSCAPE THICKNESS

WOOD BASE	LANDSCAPE	THICKNESS			
13.011L	A4	2mm	x10	↔	↺
13.012L	A5	2mm	x10	↔	↺
13.013L	A6	2mm	x10	↔	↺

## HOLDER DETAILS



## INFORMATION

\*mm

This acrylic sign Holder with stylish oval wooden base is available in 3 sizes (A4, A5 and A6). It is designed for portrait orientation of graphics.

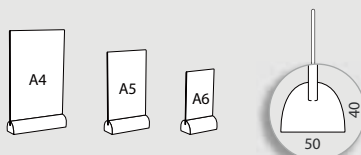

WOOD BASE PORTRAIT THICKNESS

WOOD BASE	PORTRAIT	THICKNESS			
13.391P	A4	2mm	x10	↑	↺
13.392P	A5	2mm	x10	↑	↺
13.393P	A6	2mm	x10	↑	↺

## OVAL WOOD BASE HOLDER



## INFORMATION

\*mm

This acrylic sign Holder with stylish oval wooden base is available in 3 sizes (A4, A5 and A6). It is designed for portrait orientation of graphics.

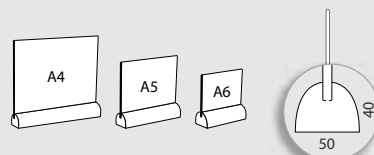

WOOD BASE LANDSCAPE THICKNESS

WOOD BASE	LANDSCAPE	THICKNESS			
13.391L	A4	2mm	x10	↔	↺
13.392L	A5	2mm	x10	↔	↺
13.393L	A6	2mm	x10	↔	↺

HOLDER DETAILS



INFORMATION

\* mm

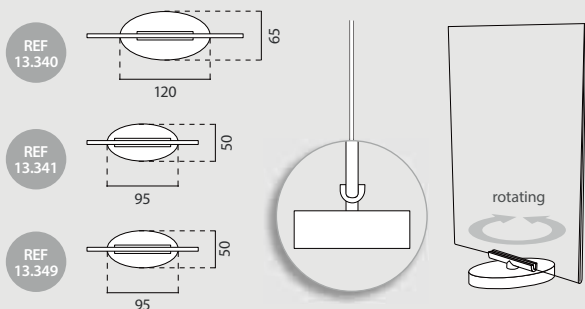

INFORMATION

This open sign frame features transparent panes with green tinted edges, providing the look of real glass. Rotating base with anti-scratch felt bottom pad. Available in 3 sizes with portrait orientation.

"SWIVEL"	PORTRAIT	THICKNESS			
13.340	A4	3mm	x2 		
13.341	A5	3mm	x4 		
13.349	1/3 A4	3mm	x4 		

"SWIVEL"  
LITERATURE HOLDER



## DISPLAY DETAILS



## DIMENSIONS

\*mm

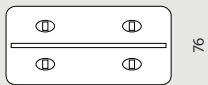

76

- Power/Discharging Indicator
- 1 micro USB input (5V/2.0A)
- 4 USB outputs (5V/2.0A)
- Total Output: 5V / 2.5A
- Capacity: 6.000 mA h
- Charge Time: ± 7-8 h

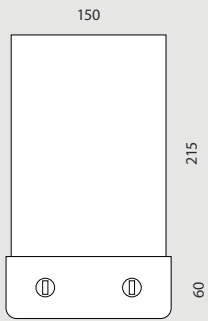

150

215

160

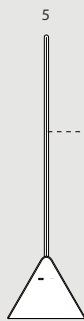

5

inner thickness: 2

76

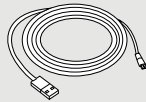

## INFORMATION

This closed sign frame features a transparent acrylic sign holder and a black rubber coating base with 4 usb connectors. It supports charging 4 devices at the same time, so it is ideal for marketing tool and a good choice for the consumers, prolonging their stay in the establishment while they are charging their devices. The portable Powerbank can be charged via DC port or via micro USB. Featuring a Power and Discharging indicator. Also, it is able to charge most electronic devices with a charging voltage of 5.0V. To charge your electronic device, connect the USB output port on the Power Bank to the input port on your device using the provided cable. This Powerbank with unique design is ideal for restaurants, coffee shops, bar, for tea-shops, etc.

POWER BANK

GRAPHICK SIZE

13.572

215x150mm

x1



## POWER BANK DISPLAY

4 USB PORTS



## DIVIDER DETAILS

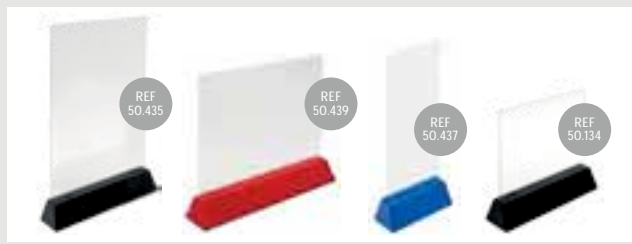

## DIMENSIONS

\*mm

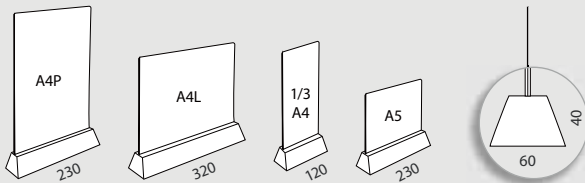

## INFORMATION

This Card Holder features a colored plastic base (3 colors available) with a transparent document holder available in 4 sizes. Ideal as marketing tool for a whole range of businesses such as restaurants, hotels, receptions, waiting rooms or supermarket as checkout divider. Graphic sheet not included.

A5 HOLDER	COLOR	SIZE	
50.134		A5 210x148mm	x10
1/3 A4 HOLDER	COLOR	SIZE	
50.437		1/3 A4 100x210mm	x10
A4 HOLDER	COLOR	SIZE	
50.439		A4 landscape 297x210mm	x10
50.435		A4 portrait 210x297mm	x10

## BASE DIVIDER



## DIVIDER DETAILS

\*mm

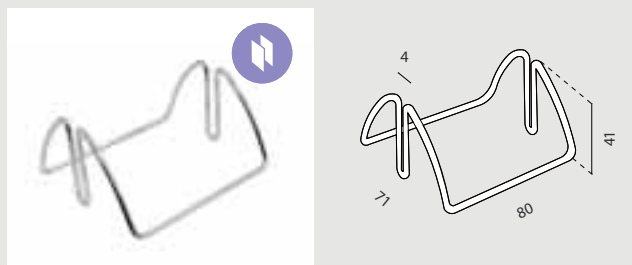

## INFORMATION

This stylish open base is made of 3mm chromed wire. Suitable for different acrylic support sizes with a maximum thickness of 4mm for double sided use. Ideal as desktop marketing tool for a whole range of businesses. Acrylic holder not included.

C.WIRE BASE	QTY	N.W	G.W	C.B.M	SIZE
Packing	1	0.32kg	0.43kg	0.0041	205x125x160 mm
13.574		Size: 80x41x71mm			x12

## CHROME WIRE BASE FOR SIGN HOLDERS



\* the graphic customization and acrylic (13.574) at this page are available but not included

## HOLDER DETAILS

\*mm

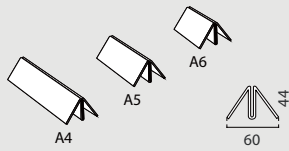

### INFORMATION

This open Card Base has an "M" shape and 3 sizes. Suitable to hold portrait or landscape orientation documents. Paper slips in easily through the top and sides.

"M"	SIZE	THICKNESS			
13.035	210mm/A4	2mm	x10 	 	
13.036	148mm/A5	2mm	x10 	 	
13.037	105mm/A6	2mm	x10 	 	

## "M" ACRYLIC HOLDER



## HOLDER DETAILS

\*mm

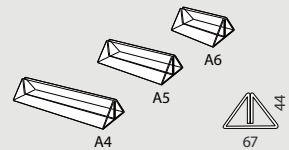

### INFORMATION

This open Base has a "Volcano" shape and 3 sizes. Suitable to hold portrait or landscape orientation documents. Paper slips in easily through the top and sides.

"A"	SIZE	THICKNESS			
13.394	210mm/A4	2mm	x10 	 	
13.395	148mm/A5	2mm	x10 	 	
13.396	105mm/A6	2mm	x10 	 	

## "A" ACRYLIC HOLDER



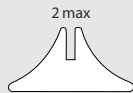

## HOLDER DETAILS

\*mm



### INFORMATION

This Luxe base made of injected Polystyrene holds A5 portrait sheets. It also allows other sizes in portrait or landscape orientation for 2mm maximum thickness. Paper slips in easily through the top.

LUXE	SIZE	THICKNESS			
13.034	148mm/A5	2mm	x10 	 	

## LUXE BASE HOLDER



## HOLDER DETAILS

\*mm

acrylic

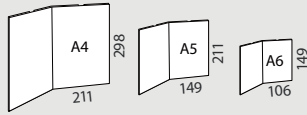

### INFORMATION

This sign holder features a double-portrait shape with double-sided viewing and 3 available sizes. Paper slips through the top and sides.

DUO	SIZE	THICKNESS			
13.283	A4x2	2mm	x5		
13.402	A5x2	2mm	x5		
13.403	A6x2	2mm	x5		

## DUO ACRYLIC HOLDER



## HOLDER DETAILS

\*mm

acrylic

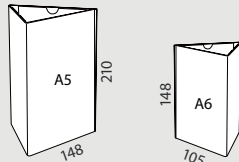

### INFORMATION

This sign holder display features a triangular prism shape with triple-sided viewing and 2 available sizes. Paper slips through the top.

TRIANGLE	SIZE	THICKNESS			
13.386	A5x3	2mm	x4		
13.387	A6x3	2mm	x4		

## TRIANGLE ACRYLIC HOLDER



## HOLDER DETAILS

\*mm

acrylic

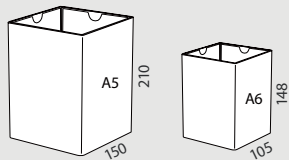

### INFORMATION

This sign holder features a square prism shape with quadruple-sided viewing and 2 available sizes. Paper slips through the top.

SQUARE	SIZE	THICKNESS			
13.388	A5x4	2mm	x4		
13.389	A6x4	2mm	x4		

## SQUARE ACRYLIC HOLDER



## HOLDER DETAILS

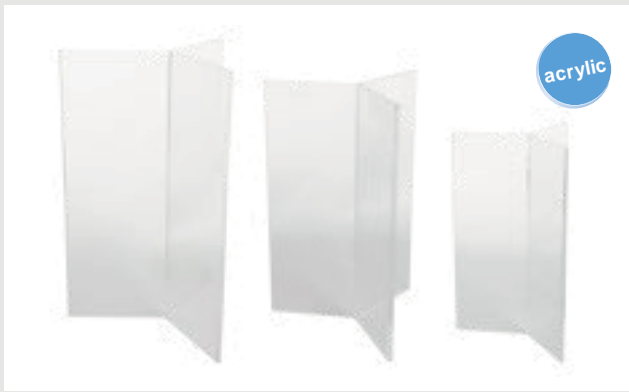

## INFORMATION

\* mm

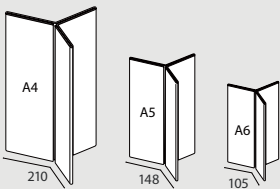

This Sign Holder features a "Y" shape. Available in 3 sizes with portrait orientation. This Sign Holder display is designed for triple-sided viewing. Paper slips through the top. Ideal for restaurants or coffee centers as a menu holder.

"Y"	SIZE	THICKNESS			
13.014	A4x3	2mm	x6		
13.015	A5x3	2mm	x6		
13.390	A6x3	2mm	x6		

## "Y" ACRYLIC HOLDER



## HOLDER DETAILS



## INFORMATION

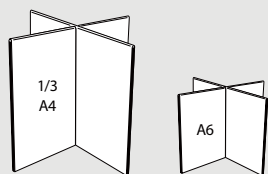

This Sign Holder features a cross shape. 3 sizes available with portrait orientation. This Sign Holder display is designed for quadruple-sided viewing. Paper slips through the top. Ideal for restaurants or coffee centers as a menu holder.

"X"	SIZE	THICKNESS			
13.437	A6	2mm	x5		
13.438	1/3 A4	2mm	x5		

## "X" ACRYLIC HOLDER



HOLDER DETAILS



INFORMATION

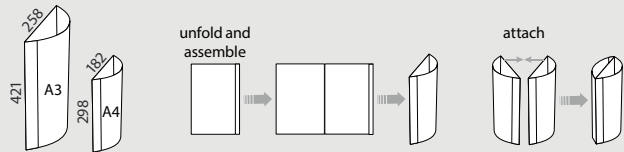

CURVED	SIZE	THICKNESS			
13.420	A3	0.4mm	x10		
13.421	A4	0.4mm	x10		

CURVED PVC DISPLAY



HOLDER DETAILS



INFORMATION

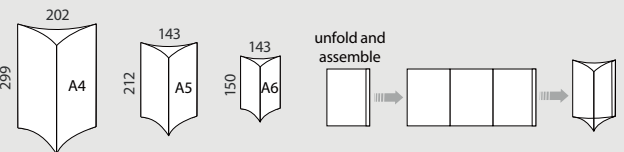

TRIANGLE	SIZE	THICKNESS			
13.422	A4x3	0.4mm	x10		
13.423	A5x3	0.4mm	x10		
13.424	A6x3	0.4mm	x10		

TRIANGLE PVC DISPLAY

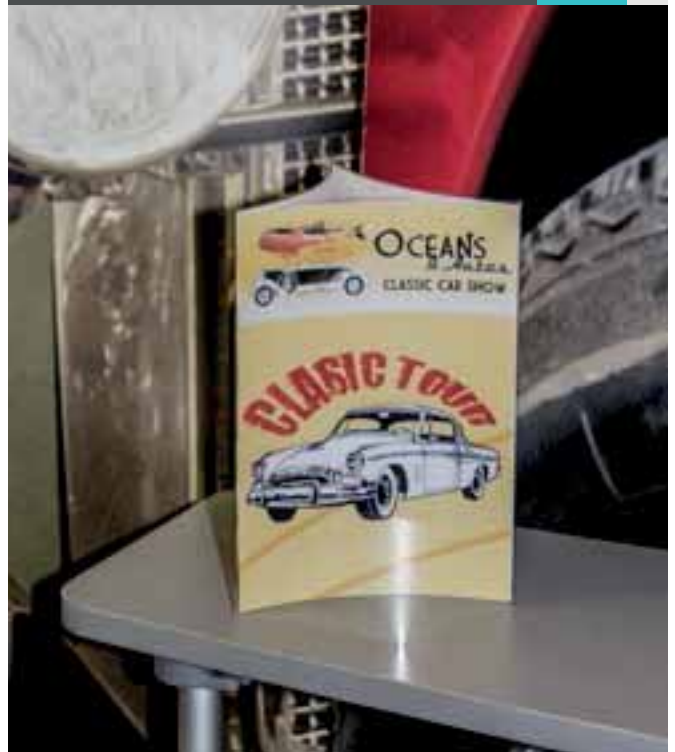

## HOLDER DETAILS



## INFORMATION

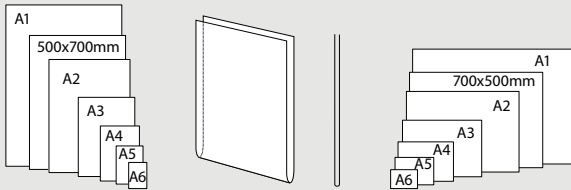

This sign pocket made of acrylic featuring landscape or portrait orientation and 7 available sizes. Suitable for wall mounting or hanging from ceiling for double-sided viewing. Paper slips in easily through the top and sides. Product supplied without holes.

SANDWICH	PORTRAIT	THICKNESS			
13.020P	A1	2mm	x5 		
13.021P	A2	2mm	x5 		
13.022P	A3	2mm	x5 		
13.023P	A4	2mm	x10 		
13.024P	A5	2mm	x10 		
13.025P	A6	2mm	x10 		
13.026P	500x700mm	2mm	x5 		

  

SANDWICH	LANDSCAPE	THICKNESS			
13.020L	A1	2mm	x5 		
13.021L	A2	2mm	x5 		
13.022L	A3	2mm	x5 		
13.023L	A4	2mm	x10 		
13.024L	A5	2mm	x10 		
13.025L	A6	2mm	x10 		
13.026L	500x700mm	2mm	x5 		

## ACRYLIC POCKET



## INFORMATION

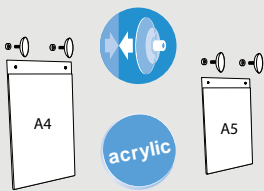

This acrylic Sign Pocket is made of acrylic and it is suitable for fixing on glass or flat surfaces thanks to its suction cups, which are included. Featuring portrait orientation with 2 sizes available. This "Sandwich" Sign Holder is designed for double-sided viewing. Paper slips in easily through the top and sides.

S.C. SANDWICH	SIZE	THICKNESS			
13.376	A4	2mm	x5 		
13.397	A5	2mm	x5 		

## ACRYLIC POCKET WITH SUCTION CUPS



## HOLDER DETAILS



## DIMENSIONS



## INFORMATION

This sign wall Pocket is made of acrylic. Featuring portrait or landscape orientation with 3 available sizes (A3, A4 and A5 format). This "Sandwich" Pocket has 2 holes at the top for hanging from ceiling or wall mounting. The paper slips in easily through the sides of the pocket.

W.SANDWICH	PORTRAIT	THICKNESS				
13.371P	A3	2mm	x5			
13.372P	A4	2mm	x5			
13.373P	A5	2mm	x5			
W.SANDWICH	LANDSCAPE	THICKNESS				
13.371L	A3	2mm	x5			
13.372L	A4	2mm	x5			
13.373L	A5	2mm	x5			

## ACRYLIC WALL POCKET



## HOLDER DETAILS

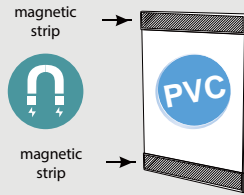

### INFORMATION

This open display features a portrait shape and 7 sizes for documents. Includes 2 magnetic strips at the back side for fixing on metallic surfaces. Paper slips in easily through the sides.

SANDWICH	PORTRAIT	THICKNESS				
13.425	A1	0.5mm	x10			
13.426	A2	0.5mm	x10			
13.052	A3	0.5mm	x10			
13.053	A4	0.5mm	x10			
13.054	A5	0.5mm	x20			
13.055	A6	0.5mm	x20			
13.427	A7	0.5mm	x30			

## MAGNETIC PVC POCKET



## HOLDER DETAILS

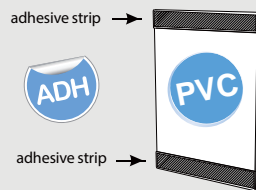

### INFORMATION

This open display features a portrait shape and 7 sizes for documents. Includes 2 adhesive strips at the back side for fixing on different surfaces. Paper slips in easily through the sides.

SANDWICH	PORTRAIT	THICKNESS				
13.428	A1	0.5mm	x10			
13.429	A2	0.5mm	x10			
13.064	A3	0.5mm	x10			
13.065	A4	0.5mm	x10			
13.066	A5	0.5mm	x20			
13.067	A6	0.5mm	x20			
13.430	A7	0.5mm	x30			

## ADHESIVE PVC POCKET



## SMALL TRIARAMA MOBILE KIT

### TRIARAMA DETAIL

### INFORMATION \*mm

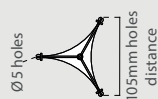
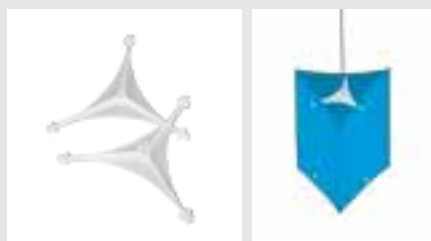

This 3-sided mobile kit has a Graphic size from A4 size up to 400mm (200mm minimum size).

### SMALL TRIARAMA

12.067

x2 

## MEDIUM TRIARAMA MOBILE KIT

### TRIARAMA DETAIL

### INFORMATION \*mm

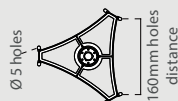

This 3-sided mobile kit has a Graphic size from A4 size up to 400mm (200mm minimum size).

### MEDIUM TRIARAMA

12.235

x2 

## BIG TRIARAMA MOBILE KIT

### TRIARAMA DETAIL

### INFORMATION \*mm

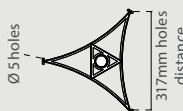
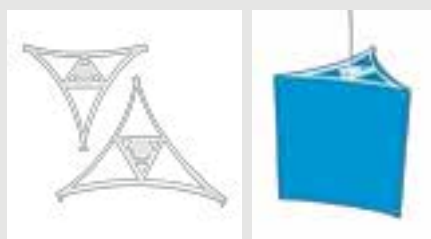

This 3-sided mobile kit has a Graphic size from 400mm up to 750mm (330mm minimum size).

### BIG TRIARAMA

12.234

x2 

## CUADRAMA MOBILE KIT

### QUADRAMA DETAIL

### INFORMATION \*mm



This 4-sided mobile kit has a Graphic size from A4 size up to 400mm (200mm minimum size).

### QUADRAMA

12.236

x2 



\* the graphics at this page are available but not included

PROFILE DETAILS



INFORMATION

CheapClip Kit includes 1 profile and 2 hangers. There are 3 profile lengths and 3 colors to choose from. Its snap-on locking system ensures a firm grip. Ideal for suspending posters to the ceiling or wall.



CHEAP 500	QTY	N.W	G.W	C.B.M	SIZE
Packing	12	0.16kg	0.36kg	0.014	360x80x520mm
10.621	<input type="checkbox"/>	Length: 500mm		x12	
10.622	<input type="checkbox"/>				
10.623	<input type="checkbox"/>				
CHEAP 800	QTY	N.W	G.W	C.B.M	SIZE
Packing	12	0.28kg	0.48kg	0.023	360x80x820mm
10.624	<input type="checkbox"/>	Length: 800mm		x12	
10.625	<input type="checkbox"/>				
10.626	<input type="checkbox"/>				
CHEAP 1000	QTY	N.W	G.W	C.B.M	SIZE
Packing	12	0.36kg	0.56kg	0.029	360x80x1020mm
10.627	<input type="checkbox"/>	Length: 1000mm		x12	
10.628	<input type="checkbox"/>				
10.629	<input type="checkbox"/>				

CHEAPCLIP



PROFILE DETAILS



INFORMATION

SoftClip Kit includes 1 profile and 2 hangers. There are 3 profile lengths and 3 colors to choose from. Its snap-on locking system ensures a firm grip. Ideal for suspending posters to the ceiling or wall.



SOFT 500	QTY	N.W	G.W	C.B.M	SIZE
Packing	12	0.28kg	0.4kg	0.014	360x80x520mm
10.612	<input type="checkbox"/>	500mm		x12	
10.613	<input type="checkbox"/>				
10.614	<input type="checkbox"/>				
SOFT 800	QTY	N.W	G.W	C.B.M	SIZE
Packing	12	0.52kg	0.72kg	0.023	360x80x820mm
10.615	<input type="checkbox"/>	800mm		x12	
10.616	<input type="checkbox"/>				
10.617	<input type="checkbox"/>				
SOFT 1000	QTY	N.W	G.W	C.B.M	SIZE
Packing	12	0.72kg	0.91kg	0.029	360x80x1020mm
10.618	<input type="checkbox"/>	1000mm		x12	
10.619	<input type="checkbox"/>				
10.620	<input type="checkbox"/>				

SOFTCLIP





PROFILE DETAILS



INFORMATION

BestClip Kit includes 1 profile and 2 hangers. There are 3 profile lengths and 3 colors to choose from. Its snap-on locking system ensures a firm grip. Ideal for suspending posters to the ceiling or wall.



BEST 500	QTY	N.W	G.W	C.B.M	SIZE
Packing	12	0.4kg	0.6kg	0.014	360x80x520mm
10.603	<input type="checkbox"/>	500mm			x12 
10.604	<input type="checkbox"/>				
10.605	<input type="checkbox"/>				
BEST 800	QTY	N.W	G.W	C.B.M	SIZE
Packing	12	0.64kg	0.84kg	0.023	360x80x820mm
10.606	<input type="checkbox"/>	800mm			x12 
10.607	<input type="checkbox"/>				
10.608	<input type="checkbox"/>				
BEST 1000	QTY	N.W	G.W	C.B.M	SIZE
Packing	12	0.72kg	0.92kg	0.029	360x80x1020mm
10.609	<input type="checkbox"/>	1000mm			x12 
10.610	<input type="checkbox"/>				
10.611	<input type="checkbox"/>				

BESTCLIP



PROFILE DETAILS



INFORMATION

StrongClip Kit includes 1 profile and 2 hangers. There are 3 profile lengths and 3 colors to choose from. Its snap-on locking system ensures a firm grip. Ideal for suspending posters to the ceiling or wall.



STRONG 500	QTY	N.W	G.W	C.B.M	SIZE
Packing	12	0.52kg	0.72kg	0.029	360x160x520mm
10.630	<input type="checkbox"/>	500mm			x12 
10.631	<input type="checkbox"/>				
10.632	<input type="checkbox"/>				
STRONG 800	QTY	N.W	G.W	C.B.M	SIZE
Packing	12	1kg	1.2kg	0.035	270x160x820mm
10.633	<input type="checkbox"/>	800mm			x12 
10.634	<input type="checkbox"/>				
10.635	<input type="checkbox"/>				
STRONG 1000	QTY	N.W	G.W	C.B.M	SIZE
Packing	12	1.2kg	1.4kg	0.044	270x160x1020mm
10.636	<input type="checkbox"/>	1000mm			x12 
10.637	<input type="checkbox"/>				
10.638	<input type="checkbox"/>				

STRONGCLIP



PLASTICLIP



PROFILE DETAILS



KIT INCLUDES

PROFILE \*mm



INFORMATION

PlastiClip Kit includes: 2 upper hooks (which are adjustable along the top rail) and 1 poster profile with snap-on locking system which ensures a firm grip. Also, PlastiClip features 5 profile lengths and 2 colors available. Ideal for suspending posters, "banner" promotions, special offers or prices to the ceiling over the products at the supermarkets or malls.

PLASTI 440	QTY	N.W	G.W	C.B.M	SIZE
Packing	12	0.48kg	0.68kg	0.004	130x90x440mm
10.526	<input type="checkbox"/>	440mm		x12	
10.527	<input checked="" type="checkbox"/>				
PLASTI 500	QTY	N.W	G.W	C.B.M	SIZE
Packing	12	0.6kg	0.8kg	0.005	130x90x500mm
10.528	<input type="checkbox"/>	500mm		x12	
10.529	<input checked="" type="checkbox"/>				
PLASTI 600	QTY	N.W	G.W	C.B.M	SIZE
Packing	12	0.72kg	0.92kg	0.007	360x90x600mm
10.530	<input type="checkbox"/>	600mm		x12	
10.531	<input checked="" type="checkbox"/>				
PLASTI 800	QTY	N.W	G.W	C.B.M	SIZE
Packing	12	0.88kg	1.05kg	0.009	130x90x800mm
10.532	<input type="checkbox"/>	800mm		x12	
10.533	<input checked="" type="checkbox"/>				
PLASTI 1000	QTY	N.W	G.W	C.B.M	SIZE
Packing	12	1.08kg	1.2kg	0.01	130x90x1000mm
10.534	<input type="checkbox"/>	1000mm		x12	
10.535	<input checked="" type="checkbox"/>				



## PROFILE DETAILS



## KIT INCLUDES

PROFILE \*mm



## INFORMATION

AluGrip Kit features 4 profile lengths and 2 different hangers to choose. Its gripper system ensures a firm grip. Ideal for suspending posters to the ceiling or wall.

ALUGRIP 300	QTY	N.W	G.W	C.B.M	SIZE
Packing	4	0.31kg	0.5kg	0.0008	50x45x340mm
10.172	300mm	2 Grippers (G)	x4		
ALUGRIP 500	QTY	N.W	G.W	C.B.M	SIZE
Packing	4	0.51kg	0.7kg	0.0012	50x45x540mm
10.173	500mm	3 Grippers (G)	x4		
ALUGRIP 700	QTY	N.W	G.W	C.B.M	SIZE
Packing	4	0.7kg	0.85kg	0.0017	50x45x740mm
10.174	700mm	4 Grippers (G)	x4		
ALUGRIP 1000	QTY	N.W	G.W	C.B.M	SIZE
Packing	4	1kg	1.4kg	0.0023	50x45x1040mm
10.175	1000mm	5 Grippers (G)	x4		

## GRIPPERS FOR ALUGRIP



ALU GRIPPERS	QTY	N.W	G.W	C.B.M	SIZE
Packing	10	0.025kg	0.03kg	0.0005	75x75x90mm
10.176	50mm	x10			

## ENDCAPS FOR ALUGRIP

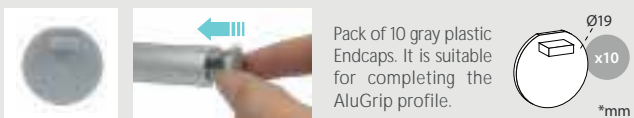

ALU ENDCAPS	QTY	N.W	G.W	C.B.M	SIZE
Packing	10	0.007kg	0.008kg	0.0005	75x75x90mm
10.177	x10				

## ALUGRIP



## SIDEVIEW HANGERS FOR ALUGRIP

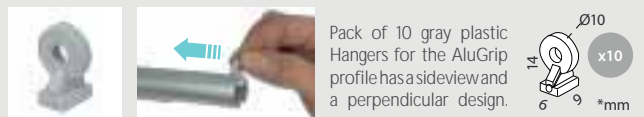

ALU HANGERS	QTY	N.W	G.W	C.B.M	SIZE
Packing	10	0.005kg	0.005kg	0.0005	75x75x90mm
10.178	x10				

## FRONTVIEW HANGERS FOR ALUGRIP

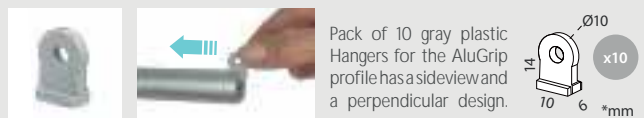

ALU HANGERS	QTY	N.W	G.W	C.B.M	SIZE
Packing	10	0.006kg	0.01kg	0.00004	65x10x65mm
10.179	x10				

PROFILE DETAILS



KIT INCLUDES

PROFILE \*mm



INFORMATION

AluPoster features 6 profile lengths. Its click locking system profile ensures a firm grip for the graphic. Ideal for suspending posters to the ceiling or wall.

ALUPOSTER 300	QTY	N.W	G.W	C.B.M	SIZE
Packing	4	0.4kg	0.6kg	0.0014	80x60x310mm
10.086		300mm		x4	
ALUPOSTER 500	QTY	N.W	G.W	C.B.M	SIZE
Packing	4	0.72kg	0.92kg	0.0024	80x60x510mm
10.087		500mm		x4	
ALUPOSTER 800	QTY	N.W	G.W	C.B.M	SIZE
Packing	4	1.12kg	1.32kg	0.0038	80x60x810mm
10.088		800mm		x4	
ALUPOSTER 1000	QTY	N.W	G.W	C.B.M	SIZE
Packing	4	1.48kg	1.68kg	0.0048	80x60x1010mm
10.089		1000mm		x4	
ALUPOSTER 1200	QTY	N.W	G.W	C.B.M	SIZE
Packing	4	1.68kg	1.88kg	0.0058	80x60x1210mm
10.090		1200mm		x4	
ALUPOSTER 1500	QTY	N.W	G.W	C.B.M	SIZE
Packing	4	2kg	2.2kg	0.0072	80x60x1510mm
10.091		1500mm		x4	

ENDCAPS FOR ALUPOSTER



Pack of 10 grey plastic Endcaps for completing this profile. Ideal for changing the overall look of the Aluposter System.

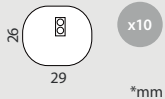

P. ENDCAP	QTY	N.W	G.W	C.B.M	SIZE
Packing	1	0.009kg	0.02kg	0.00004	65x10x65mm
13.399		x10			

ALUPOSTER



RING CLIP FOR ALUPOSTER



Pack of 10 grey plastic Hanger Ring Clips for suspending the AluPoster profile. Ideal for being used with Nylon Roll.

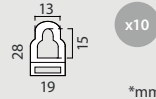

RING CLIP	QTY	N.W	G.W	C.B.M	SIZE
Packing	1	0.047kg	0.01kg	0.00004	65x10x65mm
13.400		x10			

PROFILE DETAILS



KIT INCLUDES

PROFILE \*mm



INFORMATION

The AluClip features 6 profile lengths. Its clic locking system ensures a firm grip for the graphic. Ideal for suspending posters to the ceiling or the wall.

ALUCLIP 300	QTY	N.W	G.W	C.B.M	SIZE
Packing	4	0.35kg	0.5kg	0.0009	65x40x320mm
10.080			300mm	x4	
ALUCLIP 500	QTY	N.W	G.W	C.B.M	SIZE
Packing	4	0.57kg	0.8kg	0.0014	65x40x540mm
10.081			500mm	x4	
ALUCLIP 800	QTY	N.W	G.W	C.B.M	SIZE
Packing	4	0.9kg	1.2kg	0.0022	65x40x840mm
10.082			800mm	x4	
ALUCLIP 1000	QTY	N.W	G.W	C.B.M	SIZE
Packing	4	1.2kg	1.5kg	0.0027	65x40x1040mm
10.083			1000mm	x4	
ALUCLIP 1200	QTY	N.W	G.W	C.B.M	SIZE
Packing	4	1.4kg	1.8kg	0.0032	65x40x1240mm
10.084			1200mm	x4	
ALUCLIP 1500	QTY	N.W	G.W	C.B.M	SIZE
Packing	4	1.7kg	2.2kg	0.004	65x40x1540mm
10.085			1500mm	x4	

ENDCAPS FOR ALUCLIP



A Pack of 10 black plastic Endcaps is ideal for completing the AluClip profile.

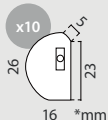

P. ENDCAP	QTY	N.W	G.W	C.B.M	SIZE
Packing	1	0.009kg	0.02kg	0.00004	65x10x65mm
13.398			x10		

ALUCLIP



RING CLIP FOR ALUCLIP



This Pack of 10 plastic Hanger Ring Clip for suspending the AlupClip profile system is ideal for changing the look of the Aluclip Profile System.

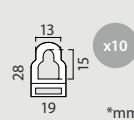

RING CLIP	QTY	N.W	G.W	C.B.M	SIZE
Packing	1	0.047kg	0.01kg	0.00004	65x10x65mm
13.400			x10		

PROFILE DETAILS



KIT INCLUDES

PROFILE \*mm

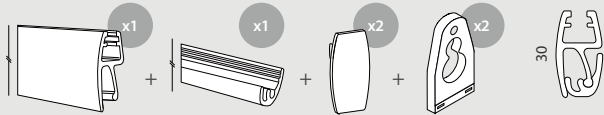

INFORMATION

Alulon features 6 profile lengths. Its snap-on locking system ensures a firm grip for the graphic. Ideal for suspending posters to the ceiling or the wall.

ALULON 500	QTY	N.W	G.W	C.B.M	SIZE
Packing	4	1.2kg	1.4kg	0.0017	540x90x35mm
10.571		500mm		x4	
ALULON 800	QTY	N.W	G.W	C.B.M	SIZE
Packing	4	1.8kg	2.1kg	0.0026	90x35x840mm
10.191		800mm		x4	
ALULON 1000	QTY	N.W	G.W	C.B.M	SIZE
Packing	4	2.2kg	2.6kg	0.0033	90x35x1040mm
10.572		1000mm		x4	
ALULON 1200	QTY	N.W	G.W	C.B.M	SIZE
Packing	4	2.7kg	3kg	0.0039	90x35x1240mm
10.193		1200mm		x4	
ALULON 1500	QTY	N.W	G.W	C.B.M	SIZE
Packing	4	3.4kg	3.8kg	0.0049	90x35x1540mm
10.194		1500mm		x4	
ALULON 3000	QTY	N.W	G.W	C.B.M	SIZE
Packing	4	6.5kg	7.4kg	0.0123	90x45x3025mm
10.195		3000mm		x4	

ENDCAPS FOR ALULON



A Pack of 10 black plastic Endcaps is ideal for completing the Alulon profile.



ENDCAP	QTY	N.W	G.W	C.B.M	SIZE
Packing	1	0.009kg	0.02kg	0.00004	65x10x65mm
10.196		x10			

ALULON



RING CLIP FOR ALULON



A Pack of 10 plastic Hanger Ring Clip. It is ideal for suspending the Alulon System profile.

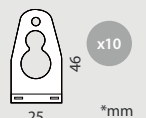

H.RING CLIP	QTY	N.W	G.W	C.B.M	SIZE
Packing	1	0.047kg	0.01kg	0.00004	65x10x65mm
10.197		x10			

PROFILE DETAILS



KIT INCLUDES

PROFILE \*mm



INFORMATION

The FastClip System Kit includes: 2 upper grey plastic hangers (which are adjustable along the top rail), 2 grey plastic endcaps and 1 aluminium profile with a pack of retainers which ensures a firm grip for the poster or graphic. Also, FastClip features 6 aluminium profile lengths available. Ideal for suspending posters, "banner" promotions, special offers or prices to the ceiling over the products at retail stores or the supermarkets.

FASTCLIP 300	QTY	N.W	G.W	C.B.M	SIZE
Packing	4	0.65kg	0.8kg	0.0018	340x90x60mm
50.600	300mm	5 Retainers (R)		x4	

  

FASTCLIP 500	QTY	N.W	G.W	C.B.M	SIZE
Packing	4	1.17kg	1.4kg	0.0029	540x90x60mm
50.601	500mm	9 Retainers (R)		x4	

  

FASTCLIP 800	QTY	N.W	G.W	C.B.M	SIZE
Packing	4	1.7kg	2kg	0.0045	840x90x60mm
50.602	800mm	15 Retainers (R)		x4	

  

FASTCLIP 1000	QTY	N.W	G.W	C.B.M	SIZE
Packing	4	2kg	2.45kg	0.0056	90x60x1040mm
50.603	1000mm	19 Retainers (R)		x4	

FASTCLIP 1200	QTY	N.W	G.W	C.B.M	SIZE
Packing	4	2.4kg	2.9kg	0.0067	90x60x1240mm
50.604	1200mm	24 Retainers (R)		x4	

FASTCLIP 1500	QTY	N.W	G.W	C.B.M	SIZE
Packing	4	2.9kg	3.5kg	0.0083	90x60x1540mm
50.605	1500mm	30 Retainers (R)		x4	

FASTCLIP



PROFILE DETAILS



KIT INCLUDES

PROFILE \*mm



INFORMATION

The Semi Circular FastClip Kit includes: 2 upper hooks (which are adjustable along the top rail), 2 plastic endcaps, 1 poster profile with an adhesive strip on their back face and a pack of retainers which ensures a firm grip. Also, Semi Circular FastClip features 6 profile lengths available. Ideal for suspending posters, "banner" promotions, special offers or prices to the ceiling over the products at the supermarkets or retails stores.

SEMI C.F.300	QTY	N.W	G.W	C.B.M	SIZE
Packing	4	0.45kg	0.6kg	0.0015	340x100x45mm
50.606	300mm		5 Retainers (R)	x4	

  

SEMI C.F.500	QTY	N.W	G.W	C.B.M	SIZE
Packing	4	0.7kg	1kg	0.0024	100x45x540mm
50.607	500mm		9 Retainers (R)	x4	

  

SEMI C.F.800	QTY	N.W	G.W	C.B.M	SIZE
Packing	4	1kg	1.4kg	0.0038	100x45x840mm
50.608	800mm		15 Retainers (R)	x4	

  

SEMI C.F.1000	QTY	N.W	G.W	C.B.M	SIZE
Packing	4	1.3kg	1.8kg	0.0047	100x45x1040mm
50.609	1000mm		19 Retainers (R)	x4	

SEMI C.F.1200	QTY	N.W	G.W	C.B.M	SIZE
Packing	4	1.5kg	2.1kg	0.0056	100x45x1250mm
50.610	1200mm		24 Retainers (R)	x4	

SEMI C.F.1500	QTY	N.W	G.W	C.B.M	SIZE
Packing	4	1.95kg	2.5kg	0.0069	100x45x1540mm
50.611	1500mm		30 Retainers (R)	x4	

SEMI CIRCULAR FASTCLIP



The Decorail is a profile system composed by an aluminium profile in which they can anchor **multiple advertising systems**. Ideal for **islands** and **supermarket modules**.

## DECORAIL



### ALUMINIUM PROFILE FOR DECORAIL

#### PROFILE DETAILS



#### INFORMATION

\*mm

The Decorail 47 mm high aluminium profile offers the optional opportunity to customize the inside front with a graphic. Ideal for promoting offers, products as priceholders, suspending signage over products, increasing their visibility in supermarket sections.

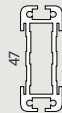

PROFILE	QTY	N.W	G.W	C.B.M	SIZE
Packing	4	6.5kg	7.4kg	0.0123	90x45x3025mm
50.620	3000mm		x4 		

### ENDCAP FOR DECORAIL

#### ENDCAP DETAILS



#### INFORMATION

\*mm

This pack of 10 Endcaps is made of plastic with a grey finish. They avoid the extraction of the profile graphic. With a simple insertion, they are ideal for completing the Decorail Profile Kit.

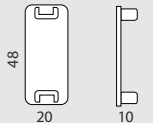

ENDCAP	QTY	N.W	G.W	C.B.M	SIZE
Packing	1	0.009kg	0.02kg	0.0004	65x10x65mm
50.622			x10 		

### HANGER RING CLIP FOR DECORAIL

#### HANGER DETAILS



#### INFORMATION

\*mm

This pack of 10 Hangers are made of plastic with a grey finish. They allow the hanging and side shift of the profile. Featuring 3 different diameters for suspending. With a simple insertion, they are ideal for completing the Decorail Profile.

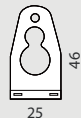

HANGER RING	QTY	N.W	G.W	C.B.M	SIZE
Packing	10	0.047kg	0.01kg	0.00004	65x10x65mm
10.197			x10 		

### CLIP HANGER FOR DECORAIL

#### CLIP DETAILS



#### INFORMATION

\*mm

This pack of 10 Clips Hangers is made of plastic. They allow the suspension and side shift of signage and promotional posters. With a simple side insertion, they are ideal for completing the Decorail Profile Kit.

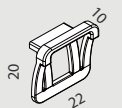

HANGER CLIP	QTY	N.W	G.W	C.B.M	SIZE
Packing	1	0.009kg	0.02kg	0.0004	65x10x65mm
50.623			x10 		

## SIGN SYSTEM CONTENT

EN	Standard signage system for indoor use. Straight aluminium profile. Recommended materials: digital printing and vinyl cutting. Supplied in complete kits. Graphic and screws not included.
FR	Système de signalisation composé d'un profil en aluminium droit. Matières recommandées: papier photographique, vinyle de coupe, etc. Vendus en jeux complets. Visuel et vis non incluses.
PT	Sinalização de interior com perfil recto. Materiais recomendados: Papel fotográfico, vinil de recorte, etc. Kit completo. Impressão e parafusos de fixação não incluídos.
ES	Sistema de señalización estándar para uso interior. Perfilera de aluminio recta. Materiales recomendados: impresión digital y vinilo de corte. Kits completos. Gráfica y tornillería no incluidas.

## SIGN SYSTEM DETAILS



## INFORMATION

## PROFILE SIZE

\*mm

- Straight profile
- Plastic pieces for fixing
- Aluminium plate
- Plastic endcaps

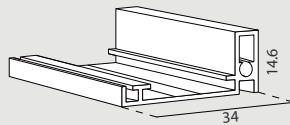

## "BARGELLO" STRAIGHT



## INSTALLING EXPLANATION

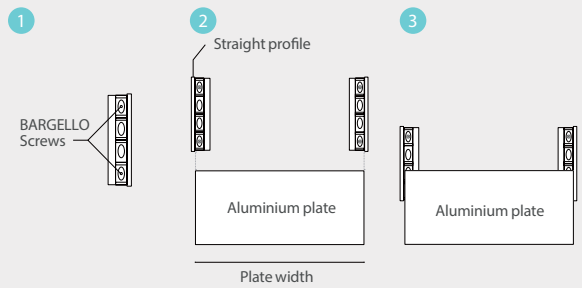

Possibility of fixing with double sided tape. Continue with the next steps if you wish to screw it to the wall:

1. Make two holes in the side profiles, as shown.
2. Screw the profiles to the wall, adjusting the width of the plate.
3. Fix the central plate by pressing on the side covers.

BARGELLO	SIZE	
15.634	120x60mm	
15.635	220x60mm	
15.636	300x60mm	
15.637	150x90mm	
15.638	220x90mm	
15.639	300x90mm	
15.668	124x120mm	
15.640	150x124mm	
15.641	220x124mm	
15.642	300x124mm	

BARGELLO	SIZE	
15.670	150x150mm	
15.643	220x150mm	
15.644	300x150mm	
15.645	400x150mm	
15.672	180x180mm	
15.646	500x60mm	
15.647	500x90mm	
15.648	500x124mm	
15.649	500x150mm	
15.650	500x180mm	

## SIGN SYSTEM CONTENT

EN	Standard signage system for indoor use. Curved aluminium profile. Recommended materials: digital printing and vinyl cutting. Supplied in complete kits. Graphic and screws not included.
FR	Système de signalisation composé d'un profil en aluminium courbé. Matières recommandées: papier photographique, vinyle de coupe, etc. Vendus en jeux complets. Visuel et vis non incluses.
PT	Sinalização de interior com perfil curvo. Materiais recomendados: Papel fotográfico, vinil de recorte, etc. Kit completo. Impressão e parafusos de fixação não incluídos.
ES	Sistema de señalización estándar para uso interior. Perfilera de aluminio curva. Materiales recomendados: impresión digital y vinilo de corte. Kits completos. Gráfica y tornillería no incluidas.

## SIGN SYSTEM DETAILS

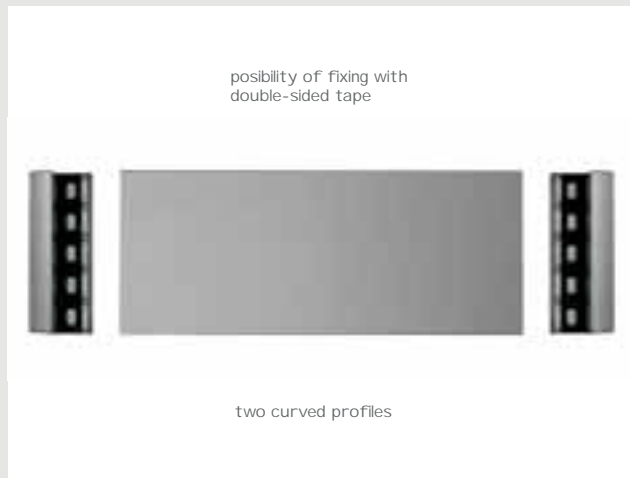

## INFORMATION

## PROFILE SIZE

\*mm

- Curved profile
- Plastic pieces for fixing
- Aluminium plate
- Plastic endcaps

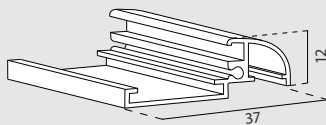

## "ORSAY" CURVED



## INSTALLING EXPLANATION

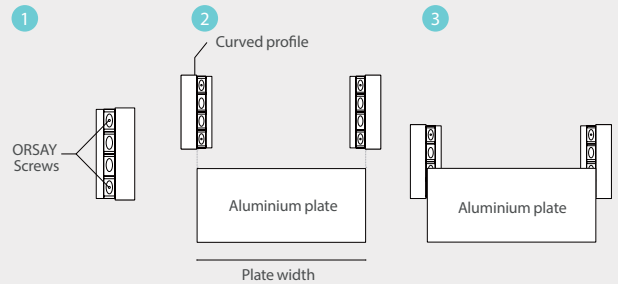

Possibility of fixing with double sided tape. Continue with the next steps if you wish to screw it to the wall:

1. Make two holes in the side profiles, as shown.
2. Screw the profiles to the wall, adjusting the width of the plate.
3. Fix the central plate by pressing on the side covers.

ORSAY	SIZE
15.651	120x60mm
15.652	220x60mm
15.653	300x60mm
15.654	150x90mm
15.655	220x90mm
15.656	300x90mm
15.657	150x124mm
15.658	220x124mm
15.659	300x124mm

ORSAY	SIZE
15.660	220x150mm
15.661	300x150mm
15.662	400x150mm
15.663	500x60mm
15.664	500x90mm
15.665	500x124mm
15.666	500x150mm
15.667	500x180mm

## SIGN SYSTEM CONTENT

EN

Signaling system composed by curved aluminum plates and side covers. Available in 3 different widths. This system allows the composition of curved wall directories according to customer needs. The components of this system are supplied separately.

FR

Système de signalisation avec profil d'aluminium courbé et bouchons latéraux. Disponible en 3 hauteurs différentes. Ce système permet la création de panneaux directionnels en fonction des besoins de clients. Les éléments de ce système sont vendus séparément.

PT

Perfil curvo de alumínio com tampas laterais para a criação de placas de sinalização. Está disponível em 3 alturas diferentes. Este sistema permite a construção de placas de sinalização mediante as necessidades do cliente. Os componentes deste sistema são vendidos por separado.

ES

Sistema de señalización compuesto por placas de aluminio curvas y tapas laterales. Disponible en 3 anchos distintos. Este sistema permite la composición de directorios de pared curvos según la necesidad del cliente. Los componentes de este sistema se suministran por separado.



## "BEYELER" CURVED SIGN SYSTEM

includes plastic protector



### EXTERNAL SIZES

\*mm



### PROFILE (PRICE FOR LINEAR METER)

HEIGHT

10.224	60mm
10.225	90mm
10.226	140mm

### PROFILE CUT

10.233	Unit cutting
--------	--------------

### PLASTIC ENDCAPS

COLOR

HEIGHT

10.227		60mm	x10 
10.230		60mm	x10 
10.228		90mm	x10 
10.231		90mm	x10 
10.229		140mm	x10 
10.232		140mm	x10 



## "VICENZA" SIGN SYSTEM



several configurations

aluminium sliding panel

### CONNECTORS SIZES

\*mm

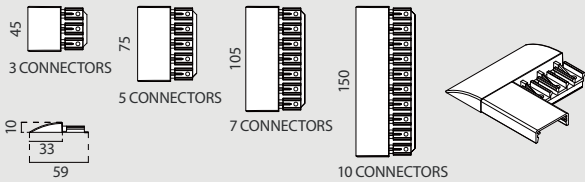

### CONNECTOR



15.310	3 Connectors	x10 
15.311	5 Connectors	x10 
15.312	7 Connectors	x10 
15.313	10 Connectors	x10 

### PROFILES DETAILS



### ALUMINIUM PROFILE



LENGTH

15.314	1 Connector	600mm	x4 
15.315	1 Connector	900mm	x4 
15.316	1 Connector	1400mm	x4 
15.317	2 Connectors	600mm	x4 
15.318	2 Connectors	900mm	x4 
15.319	2 Connectors	1400mm	x4 
15.320	3 Connectors	600mm	x4 
15.321	3 Connectors	900mm	x4 
15.322	3 Connectors	1400mm	x4 
15.323	3 Slide Connectors	600mm	x4 
15.324	3 Slide Connectors	900mm	x4 
15.325	3 Slide Connectors	1400mm	x4 







## SIGN SYSTEM CONTENT

- EN Signaling system with plastic frame that allows you to change the graphics easily. Available in different sizes.
- FR Système de signalisation en plastique qui permet le changement de visuel facilement. Disponible en plusieurs dimensions.
- PT Sistema de sinalização em plástico que permite a troca de imagem facilmente. Disponível em vários tamanhos.
- ES Sistema de señalización con marco de plástico que permite cambiar la gráfica fácilmente. Disponible en varios tamaños diferentes.

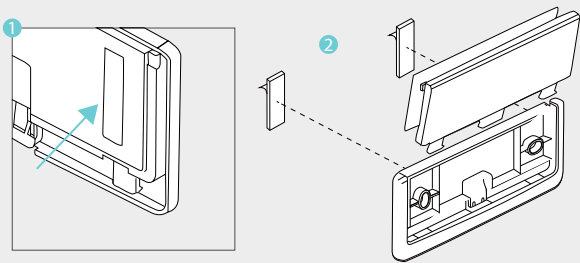

### INSTALLING EXPLANATION - FOAM ADHESIVE STRIP



DATA	SHAPE	SIZE
15.200		149x63mm
15.201		149x104mm
15.202		149x145mm

## DATA FRAME



### INSTALLING EXPLANATION - SCREWS

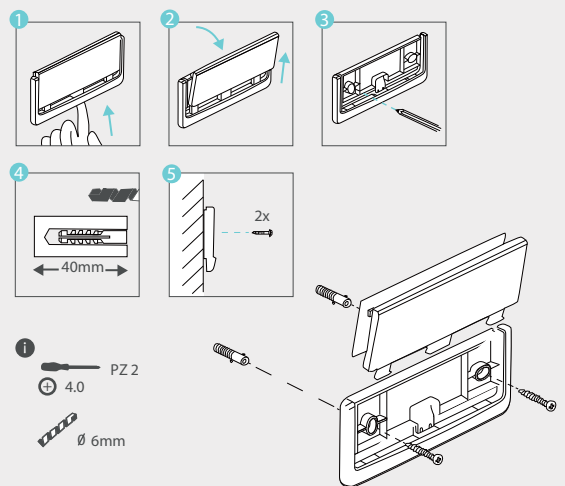

### EXTERNAL SIZE

\*mm



\* Custom printing in full color is available but not included.

ACRYLIC	SIZE
15.207	195x60mm
15.208	66x66mm

## DATA FRAME ACRYLIC



acrylic

adhesives included



## SIGN DETAILS

EN	2-sided flag sign system for fixing on the wall. Recommended materials: digital printing and vinyl cutting. Graphic and screws not included.
FR	Système composé de plaques d'aluminium 2 face à fixer au mur. Matières recommandées: vinyle decoupeet impression digitale. Graphique et visonon inclus.
PT	Sistema composto de placas de alumínio de 2 face para fixar à parede. Materiais recomendados: vinil de corte e impressão digital. Impressão e parafusos não incluídos.
ES	Sistema de señalización de banderola a 2 caras para fijar a pared. Materiales recomendados: impresión digital y vinilo de corte. Gráfica y tornillería no incluidas.



## PRINTING EXAMPLES



This is a selection of examples for printing. There are more signs available and also you can customize it with your design under request.

## SET-UP

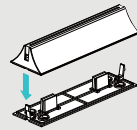

## SUPPORT

### COLOR SUPPORT



### SIZE

164x51x31mm

x5 

## SIGNAGE DOUBLE-SIDED VYNIL PRINTED

### SIZE

### THICKNESS

15.328	A5 (x2)	2mm	x5 
15.330	148x148mm (x2)	2mm	x5 

## HALLWAY SIGN



## EXTERNAL SIZES

\*mm

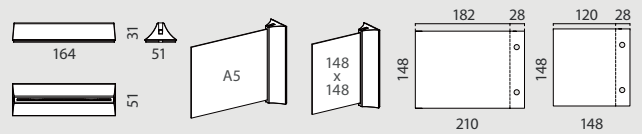

## SIGNAGE NO PRINTING

### SIZE

### THICKNESS

15.327	A5	2mm	x5 
15.329	148x148mm	2mm	x5 



## STRAIGHT FLAG



\*graphic and screws not included

## FLAG

## SIZE

15.685	220x90mm
15.686	320x90mm
15.687	220x124mm
15.688	320x124mm
15.689	420x124mm
15.690	150x150mm
15.691	220x150mm
15.692	320x150mm
15.693	420x150mm

## INSTALLING EXPLANATION

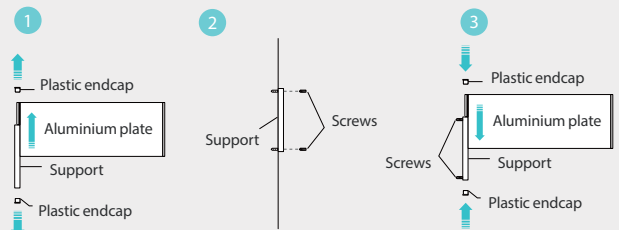

1. Remove the plastic endcaps and the aluminium plate.
2. Screw the aluminium support to the wall, as indicated.
3. Reattach the aluminium plate and the plastic endcaps.

This system contains:

- Double-sided aluminium plates
- Fixing support
- Plastic endcaps

## SIGN DETAILS

- EN Signage system with Led Light. It is supplied in complete kits. The transparent panel and mounting screws are not included.
- FR Système de signalisation avec lumière (LED). Vendus en jeux complets. Plaque transparente et vis non incluses.
- PT Sistema de sinalização com LEDs. Fornece-se em kits completos. Painel transparente e parafusos não incluídos.
- ES Sistema de señalización con luz LED. Se suministra en kits completos. Panel transparente y tornillería no incluidos.

## INFORMATION

\*mm

This system contains:

- Satin aluminium profile
- White LEDs inside
- Power supply
- Plug and wires

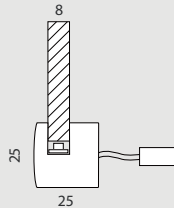



## LED LIGHT SIGN SYSTEM



\* glass or acrylic not included



LED SIGN	SIZE	LED	 
15.725	120mm	9 LEDs	
15.726	180mm	12 LEDs	
15.727	280mm	21 LEDs	

## INFORMATION

\*mm



## INFORMATION

\*mm

This pack contains:

- Stand-offs with 6 LED bulbs
- Power supply
- Plug and wires

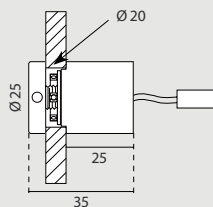



## LED LIGHT PANEL SUPPORT



\* glass or acrylic not included









LED PANEL	SIZE	LED	 
15.724	Ø25x25mm	x4	

## SIGN DETAILS

- EN Double-sided flag sign system for fixing on the wall that allows to change the graphic information easily. Available in different sizes.
- FR Système de signalisation double face à fixer au mur qui permet le changement de visuel facilement. Disponible en plusieurs dimensions.
- PT Sistema de sinalização de dupla face para fixar à parede que permite a mudança de informação facilmente. Disponível em vários tamanhos.
- ES Sistemas de señalización de banderola a doble cara que permite cambiar la gráfica fácilmente. Disponible en varios tamaños.



FLAG	SHAPE	SIZE	 
15.203		297x120mm	
15.204		120x297mm	
15.205		210x297mm	
15.206		210x210mm	

## ACRYLIC FLAG



### INSTALLING EXPLANATION

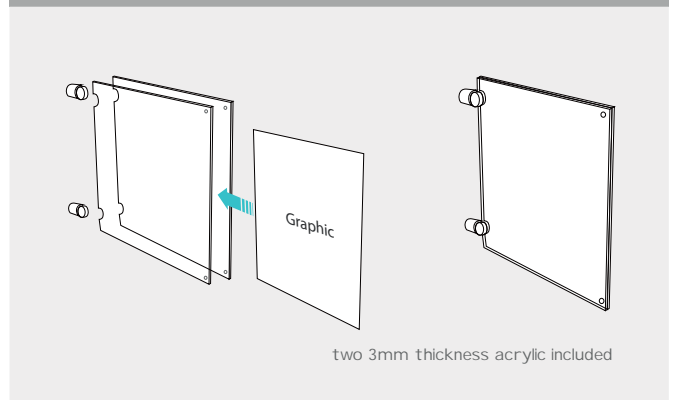

## EXTERNAL SIZES

\*mm

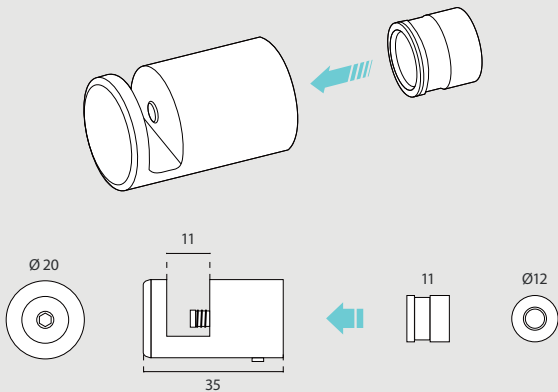

no need drilling holes on panel

MOUNTING	MAX. THICKNESS	SIZE	
15.249	11mm	Ø20x35mm	x4 

## SIGNAGE MOUNTING



### INSTALLING EXPLANATION

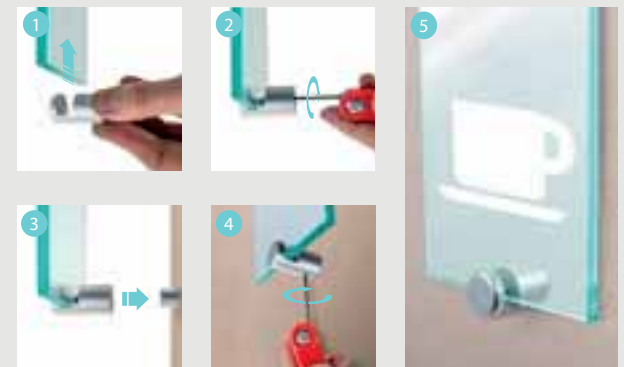

## PLASTIC STANDOFFS FIXING

### SIGN DETAILS

EN	Wall mounting system for signage. This system allows to cover the fixing screws. Available in various finishes and colors.
FR	Système de fixation d'affiches au mur. Ce système permet de couvrir les vis de fixation. Diverses finitions et couleurs disponibles.
PT	Sistemas de fixação à parede de cartazes e ocultação de parafusos. Disponível em diferentes acabamentos e cores.
ES	Sistemas de fijación a pared de cartelería. Este sistema permite cubrir los tornillos de fijación. Disponible en varios acabados y colores.

easy wall mounting



### EXTERNAL SIZE

\*mm

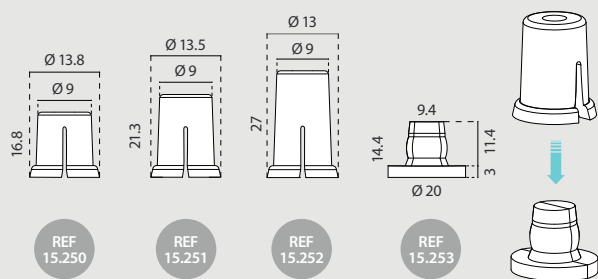

REF  
15.250

REF  
15.251

REF  
15.252

REF  
15.253

### INFORMATION

The Plastic Stand-offs highlight the messages by adding a spacing effect. The Stand-Offs are made of Polystyrene and the mounting pieces are made of polycarbonate. 3 sizes available. Ideal to hold signs, 3D company letters or any other artworks.

### INSTALLING EXPLANATION



1. Screw the Stand-Offs directly to the wall.
2. Attach the Mounting pieces to the Signage .
3. Fix the Signage with Mounting Pieces to the Stand-Offs.

### PLASTIC STANDOFF 16.8mm

SIZE

15.250



16.8mm

x20 

### PLASTIC STANDOFF 21.3mm

SIZE

15.251



21.3mm

x20 

### PLASTIC STANDOFF 27mm

SIZE

15.252



27mm

x20 

### PLASTIC STANDOFF 14.4mm

SIZE

15.253



14.4mm

x20 

Ideal as a directory signage



### SHARPED | SPIKE

	COLOR	SIZE	
15.567		Ø8x80mm	x2



### STRAIGHT CUT

	COLOR	SIZE	
15.568		Ø8x80mm	x2

## STEEL DESK SUPPORT



### SHARPED | SPIKE

	COLOR	SIZE	
15.569		Ø8x80mm	x2



### STRAIGHT CUT

	COLOR	SIZE	
15.570		Ø8x80mm	x2



create impactful displays

## SQUARE STANDOFF EDGE CLAMP

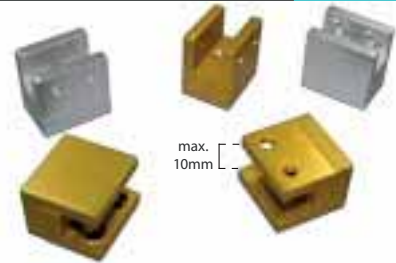

### GOLD COLOR

	COLOR	SIZE	
15.564		25x25mm	x4

### SILVER COLOR

	COLOR	SIZE	
15.565		25x25mm	x4



## ROUND STANDOFF EDGE CLAMP



2 colors and diameters available

### CHROMED COLOR

	COLOR	SIZE	
15.550		Ø25x20mm	x4
15.551		Ø30x20mm	x4

### GOLD COLOR

	COLOR	SIZE	
15.552		Ø25x20mm	x4
15.553		Ø30x20mm	x4



## GOLD-CHROMED STANDOFF





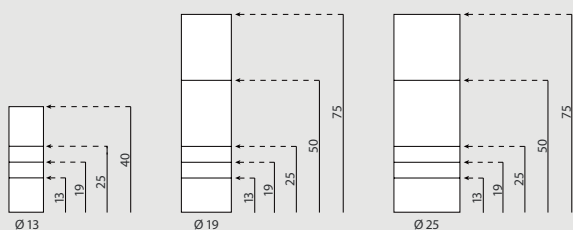

### EXTERNAL SIZES

\*mm



### GOLD-CHROMED STANDOFF Ø13mm



COLOR	SIZE		
15.500	Ø13x13mm	x4	
15.501	Ø13x19mm	x4	
15.502	Ø13x25mm	x4	
15.503	Ø13x40mm	x4	

COLOR	SIZE		
15.504	Ø13x13mm	x4	
15.505	Ø13x19mm	x4	
15.506	Ø13x25mm	x4	
15.507	Ø13x40mm	x4	













### GOLD-CHROMED STANDOFF Ø19mm

COLOR	SIZE		
15.508	Ø19x13mm	x4	
15.509	Ø19x19mm	x4	
15.510	Ø19x25mm	x4	
15.511	Ø19x50mm	x4	
15.512	Ø19x75mm	x4	

COLOR	SIZE		
15.513	Ø19x13mm	x4	
15.514	Ø19x19mm	x4	
15.515	Ø19x25mm	x4	
15.516	Ø19x50mm	x4	
15.517	Ø19x75mm	x4	

### GOLD-CHROMED STANDOFF Ø25mm

COLOR	SIZE		
15.518	Ø25x13mm	x4	
15.519	Ø25x19mm	x4	
15.520	Ø25x25mm	x4	
15.521	Ø25x50mm	x4	
15.522	Ø25x75mm	x4	

COLOR	SIZE		
15.523	Ø25x13mm	x4	
15.524	Ø25x19mm	x4	
15.525	Ø25x25mm	x4	
15.526	Ø25x50mm	x4	
15.527	Ø25x75mm	x4	





## SCREW COVERS









ideal for creating name plates and guidance systems made of glass.

### CHROMED

	COLOR	SIZE		
15.544		Ø15mm	x4 	
15.545		Ø19mm	x4 	
15.546		Ø25mm	x4 	

### GOLDEN







	COLOR	SIZE		
15.547		Ø15mm	x4 	
15.548		Ø19mm	x4 	
15.549		Ø25mm	x4 	



## ALUMINIUM STANDOFF







### Ø13x13mm

	COLOR	SIZE		
15.528		Ø13x13mm	x4 	
15.532		Ø13x13mm	x4 	
15.536		Ø13x13mm	x4 	
15.540		Ø13x13mm	x4 	

### Ø19x25mm

	COLOR	SIZE		
15.530		Ø19x25mm	x4 	
15.534		Ø19x25mm	x4 	
15.538		Ø19x25mm	x4 	
15.542		Ø19x25mm	x4 	

### Ø13x19mm

	COLOR	SIZE		
15.529		Ø13x19mm	x4 	
15.533		Ø13x19mm	x4 	
15.537		Ø13x19mm	x4 	
15.541		Ø13x19mm	x4 	

### Ø25x30mm

	COLOR	SIZE		
15.531		Ø25x30mm	x4 	
15.535		Ø25x30mm	x4 	
15.539		Ø25x30mm	x4 	
15.543		Ø25x30mm	x4 	

## SIGN DETAILS

EN	Panel Support system for shelves or for fixing posters to the wall. In gold or chrome finish. There are 2 sizes available.
FR	Système de fixation "Panel Support" d'étagères ou signalisation au mur. Disponible en chromé doré ou chromé argenté.
PT	Sistema fixação à parede de prateleiras ou impressões. Disponível em dourado ou prateado com acabamento cromado.
ES	Sistema de fijación de estantes o cartelería a pared. Disponibles en acabado dorado o cromado y en dos tamaños de fijación.



## EDGE CLAMP

	COLOR	SIZE	MAX. THICKNESS	
15.558		35x35mm	12mm	x4 
15.560		25x25mm	9.5mm	x4 

	COLOR	SIZE	MAX. THICKNESS	
15.559		35x35mm	12mm	x4 
15.561		25x25mm	9.5mm	x4 



## EDGE CLAMP

	COLOR	SIZE	MAX. THICKNESS	
15.554		30mm	7.5mm	x2 
15.555		50mm	9.5mm	x2 

	COLOR	SIZE	MAX. THICKNESS	
15.556		30mm	7.5mm	x2 
15.557		50mm	9.5mm	x2 



## EDGE CLAMP

	COLOR	SIZE	MAX. THICKNESS	
15.562		80x28mm	12mm	x4 
15.563		50x25mm	10mm	x4 

## PANEL SUPPORT EDGE CLAMP

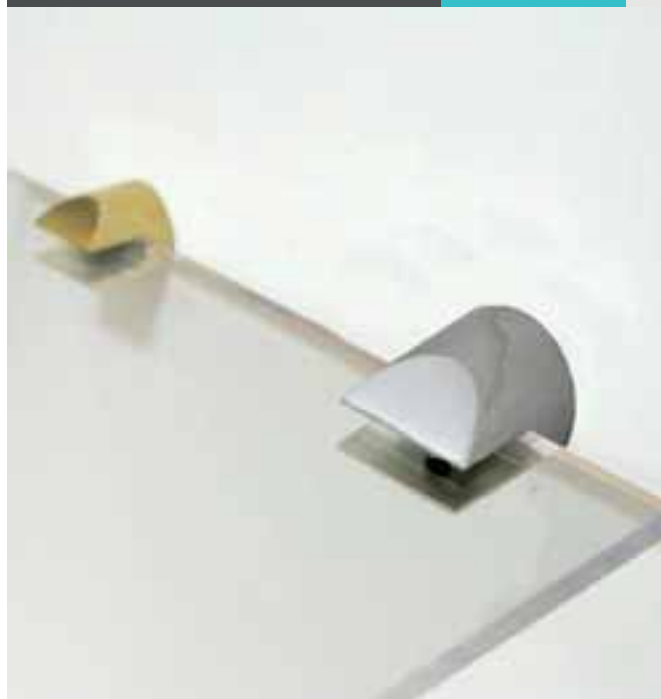

## OUTDOOR SIGN SYSTEM

### SIGN DETAILS

- EN** Outdoor signage system in two standard measures, composed by two aluminium poles for ground mounting and double sided aluminium profiles for a better viewing.
- FR** Système de signalisation extérieure en 2 dimensions standard. Composé de 2 poteaux en aluminium à fixer au sol et des profils en aluminium double face pour une meilleure visualisation.

- PT** Sistema de sinalização exterior em duas medidas standar, composto por dois postes de alumínio para fixação ao solo e perfis de alumínio com dupla face para uma melhor visualização.
- ES** Sistema de señalización exterior en dos medidas estándar, compuesto de dos postes de aluminio para fijación al suelo y perfiles de aluminio a doble cara para una mejor visualización.



### EXTERNAL SIZES

\*mm

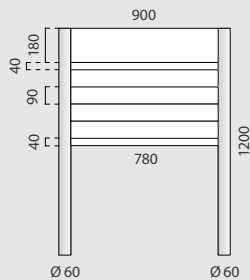

### INFORMATION

This sign includes:

- 2 aluminium poles (Ø60x1200mm)
  - 2 plastic endcaps per post
  - 1 aluminium profile 180mm height
  - 2 aluminium profiles 40mm height
  - 4 aluminium profiles 90mm height
- It is ideal for creating outdoor guidance systems.

### OUTDOOR SIGN

SIZE

15.716 900x1200mm

### EXTERNAL SIZES

\*mm

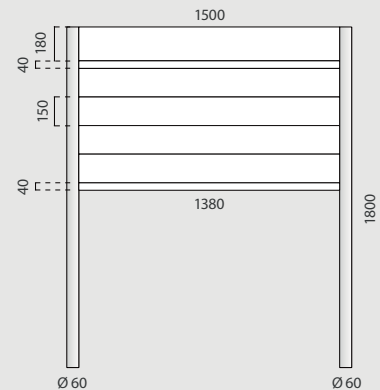

### INFORMATION

This sign includes:

- 2 aluminium poles (Ø60x1800mm)
  - 2 plastic endcaps per post
  - 1 aluminium profile 180mm height
  - 2 aluminium profiles 40mm height
  - 4 aluminium profiles 150mm height
- It is ideal for creating outdoor guidance systems.

### OUTDOOR SIGN

SIZE

15.717 1500x1800mm



# CABLEKIT 09

Complete range of signage systems through steel cables and tensors which provide an integral solution for the exhibition at selling point areas.

- 402 OMEGA SYSTEM
- 404 DELTA SYSTEM
- 406 GAMMA SYSTEM
- 408 EPSILON SYSTEM
- 410 FREE STANDING
- 411 ACRYLIC POCKET
- 412 LIGHT BOX





## OMEGA FIXING KIT

DETAIL	KIT INCLUDES	INFORMATION
		Fixing kit contains: 3m length wire cable + 1 top fixing unit + 1 bottom fixing unit. The Omega Kit is ideal for storefronts, travel agencies or for banks.
FIXING KIT		
12.547	x2 	



## OMEGA CHANNEL KIT

DETAIL	KIT INCLUDES	INFORMATION
		Channel kit contains: 3m length wire cable + 1 top channel unit + 1 bottom channel unit. Omega Kit is ideal for storefronts, travel agencies or for banks.
CHANNEL KIT		
12.546	x2 	



## OMEGA TOP FIXING

DETAIL	SIZE *mm	INFORMATION
		This metallic unit is suitable for a top fixation with the ceiling. It features a satin silver finish.
TOP FIXING	SIZE	
12.544	Ø14x24mm	x10 

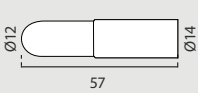

## OMEGA TOP CHANNEL

DETAIL	SIZE *mm	INFORMATION
		This metallic unit is suitable for a top fixation with channel connector. It features a satin silver finish.
TOP CHANNEL	SIZE	
12.542	Ø14x26mm	x10 

## OMEGA BOTTOM FIXING

DETAIL	SIZE *mm	INFORMATION
		Metallic unit for a bottom fixation with the floor. With a satin silver finish.
BOT. FIXING	SIZE	
12.545	Ø14x57mm	x10 

## OMEGA BOTTOM CHANNEL



DETAIL	SIZE *mm	INFORMATION
		Metallic unit for being used with channel connector. With a satin silver finish.
BOT. CHANNEL	SIZE	
12.543	Ø14x59mm	x10 

## OMEGA SYSTEM



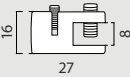

\* Acrylic Pockets at this page are available but not included

## OMEGA SINGLE POCKET CLIP

DETAIL	SIZE	*mm	INFORMATION
			This metallic single pocket clip is suitable for wires up to Ø1.5mm - Ø3mm. With silver finish.
SINGLE CLIP	SIZE		
12.540	Ø16x27mm	x10 	

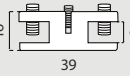



## OMEGA DOUBLE POCKET CLIP

DETAIL	SIZE	*mm	INFORMATION
			Double metallic single panel clip for wires up to Ø1.5mm - Ø3mm. With silver finish.
DOUBLE CLIP	SIZE		
12.541	Ø16x39mm	x10 	

## ALUMINIUM TRACK

DETAIL	INFORMATION
	This track aluminium features 2 lengths available (2m or 3m).
TRACK	LENGTH
12.127	2000mm
12.128	3000mm

## TRACK ENDCAP



DETAIL	SIZE	*mm	INFORMATION
			Connect this endcap to the aluminium track. Made of gray plastic.
ENCAP	SIZE		
12.428	31x25mm	x10 	

## WIRE CABLE

DETAILS	INFORMATION		
			
REF 12.315	REF 12.311		
WIRE CABLE	LENGTH	Ø WIRE	
12.315	25m	1.5mm	
12.311	25m	3mm	

Roll of wire cable suitable for Cablekit systems, with a length of 25m. 2 diameters available: Ø1.5mm and Ø3mm.









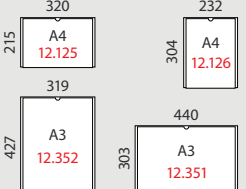

## OMEGA LOAD

DETAIL	SIZE	*mm	INFORMATION
			This Ø40 Aluminium load for wires is 500g weight. 170mm height.
LOAD	SIZE	WEIGHT	
12.117	Ø 40x170mm	500g	

## OMEGA SYSTEM



## ACRYLIC POCKET

DETAILS	INFORMATION	*mm
		
		
This transparent 2mm acrylic Pocket folder features 2 formats with 2 orientations.		
POCKET	STANDARD FORMATS	
12.125	A4 Horizontal	x10  
12.351	A3 Horizontal	x10  
12.126	A4 Vertical	x10  
12.352	A3 Vertical	x10  

## DELTA TOP/WALL FIXING

FIXING DETAIL INFORMATION \*mm

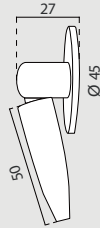

This movable and stylish Top Support is suitable for ceiling or wall. It includes adjust for tension. Convenient for wire with a diameter of Ø1.5mm or Ø3mm. With chrome finish. Ideal for storefronts, travel agencies or banks.

WALL FIXING BASE SIZE

12.316 Ø45x27mm x4 

## DELTA TOP/BOTTOM FIXING

FIXING DETAIL INFORMATION \*mm

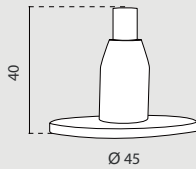

Elegant and fixed support for ceiling or floor. Convenient for wire with a diameter of Ø1.5mm or Ø3mm. With chrome finish. Ideal for real states, storefronts, travel agencies or banks.

BOTTOM FIXING SIZE

12.317 Ø45x40mm x4 

## CHROMED POCKET CLIP

CLIP DETAIL SIZE \*mm INFORMATION

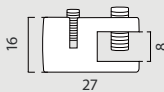

This chromed pocket fixing Clip is suitable for a single pocket. It is convenient for wire with a diameter of Ø1.5mm or Ø3mm.

CHROMED CLIP SIZE

12.318 Ø16x27mm x10 

## DOUBLE CHROMED POCKET CLIP

CLIP DETAIL SIZE \*mm INFORMATION

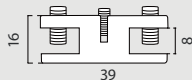

This chromed pocket fixing Clip is suitable for 2 pockets. It is convenient for wire with a diameter of Ø1.5mm or Ø3mm.

DOUBLE CH. SIZE

12.319 Ø16x39mm x10 

## DELTA SYSTEM



\* Acrylic Pockets at this page are available but not included

## WIRE CABLE Ø 1mm

### CABLE DETAIL



Roll of wire cable suitable for Cablekit systems. With a diameter of Ø1mm and a length of 25m. This hanging wire cable provides tension and firmness to the displaying of pockets.

Ø1 CABLE	LENGTH	Ø WIRE
12.121	25m	1mm

## WIRE CABLE Ø 1.5mm

### CABLE DETAIL



Roll of wire cable suitable for Cablekit systems. With a diameter of Ø1.5mm and a length of 25m. This hanging wire cable provides tension and firmness to the displaying of pockets.

Ø1.5 CABLE	LENGTH	Ø WIRE
12.315	25m	1.5mm

## WIRE CABLE Ø 3mm

### CABLE DETAIL



Roll of wire cable suitable for Cablekit systems. With a diameter of Ø3mm and a length of 25m. This hanging wire cable provides tension and firmness to the displaying of pockets.

Ø3 CABLE	LENGTH	Ø WIRE
12.311	25m	3mm

## ACRYLIC POCKET

### DETAILS

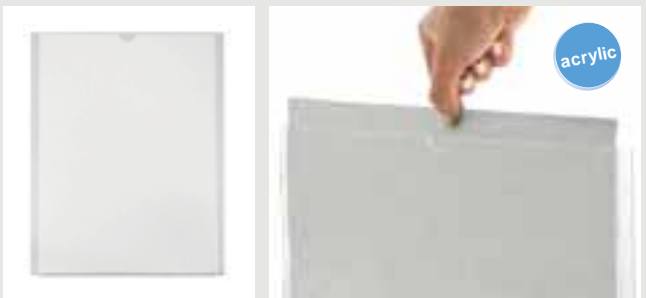

### INFORMATION

\*mm

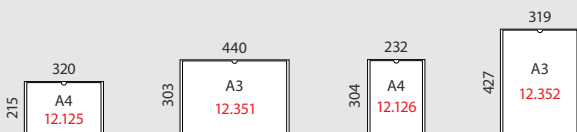

This transparent 2mm acrylic Pocket folder features 2 formats with 2 orientations.

POCKET	STANDARD FORMATS			
12.125	A4 Horizontal	x10		
12.351	A3 Horizontal	x10		
12.126	A4 Vertical	x10		
12.352	A3 Vertical	x10		

## DELTA SYSTEM



## GAMMA TOP/WALL FIXING

FIXING DETAIL SIZE \*mm

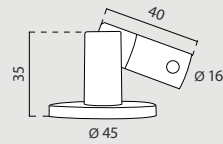

### INFORMATION

This movable and stylish Top Support is suitable for ceiling or wall. Convenient for wire with a diameter of Ø1.5mm or Ø3mm. With chrome finish. It is ideal for storefronts, travel agencies or banks.

WALL FIXING	BASE SIZE		
12.312	Ø45x35mm	x4 	

## GAMMA WALL/BOTTOM FIXING

FIXING DETAIL SIZE \*mm

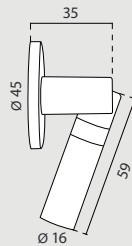

### INFORMATION

This movable and stylish bottom support is suitable for wall or floor placement. It includes adjust for tension Convenient for cable wire up to Ø1.5 - Ø3mm. With silver finish. Ideal for real states, for storefronts, travel agencies or banks, creating advertisement mosaics.

BOTTOM FIXING	BASE SIZE		
12.313	Ø45x35mm	x4 	

## GAMMA SINGLE POCKET CLIP

CLIP DETAIL



INFORMATION SIZE \*mm

This silver Vertical fixing Clip is suitable for holding a single panel. Convenient for cable wire with a diameter of Ø1.5mm or Ø3mm.

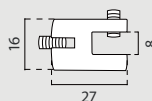

CHROMED CLIP	SIZE		
12.314	Ø16x27mm	x10 	

## GAMMA SYSTEM



\* Acrylic Pockets at this page are available but not included

# GAMMA SYSTEM



## WIRE CABLE Ø 1.5mm

### CABLE DETAIL

### INFORMATION

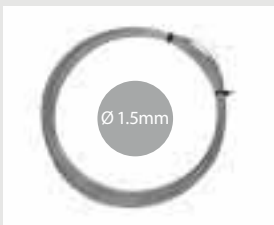

Roll of wire cable suitable for Cablekit systems. With a diameter of Ø1.5mm and a length of 25m. This hanging wire cable provides tension and firmness to the displaying of pockets.

Ø1.5 CABLE	LENGTH	Ø WIRE
12.315	25m	1.5mm

## WIRE CABLE Ø 3mm

### CABLE DETAIL

### INFORMATION



Roll of wire cable suitable for Cablekit systems. With a diameter of Ø3mm and a length of 25m. This hanging wire cable provides tension and firmness to the displaying of pockets.

Ø3 CABLE	LENGTH	Ø WIRE
12.311	25m	3mm

## ACRYLIC POCKET

### POCKET DETAILS





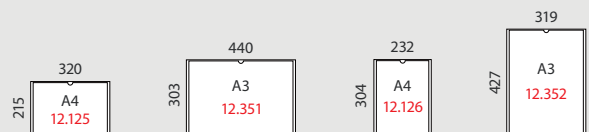

### INFORMATION

\* mm



This transparent 2mm acrylic Pocket folder features 2 formats with 2 orientations.

POCKET	STANDARD FORMATS			
12.125	A4 Horizontal	x10		
12.351	A3 Horizontal	x10		
12.126	A4 Vertical	x10		
12.352	A3 Vertical	x10		

\* Magnetic Light Boxes at this page are available but not included

## EPSILON TOP/WALL FIXING

FIXING DETAIL INFORMATION \*mm

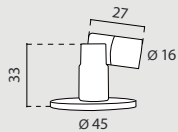

This movable and stylish Support is suitable for ceiling or wall. Convenient for cable wire up to Ø1.5 - Ø3mm. With chrome finish. Ideal for real states, for storefronts, travel agencies or banks.

BOTTOM FIXING	SIZE		
12.320	Ø45x40mm	x4 	

## EPSILON WALL/BOTTOM FIXING

FIXING DETAIL INFORMATION \*mm

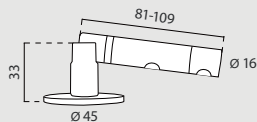

This movable and stylish Support is suitable for bottom/floor or wall. It includes adjust for tension. Convenient for cable wire up to Ø1.5 - Ø3mm. With chrome finish. Ideal for real states, travel agencies or banks.

WALL FIXING	BASE SIZE		
12.321	Ø45x33mm	x4 	

## CHROMED POCKET CLIP

CLIP DETAIL INFORMATION \*mm

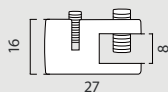

This chromed pocket fixing Clip is suitable for a single pocket. It is convenient for wire with a diameter of Ø1.5mm or Ø3mm.

CHROMED CLIP	SIZE		
12.318	Ø16x27mm	x10 	

## DOUBLE CHROMED POCKET CLIP

CLIP DETAIL INFORMATION \*mm

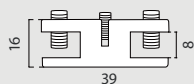

This chromed pocket fixing Clip is suitable for 2 pockets. It is convenient for wire with a diameter of Ø1.5mm or Ø3mm.

DOUBLE CH.	SIZE		
12.319	Ø16x39mm	x10 	

## EPSILON SYSTEM

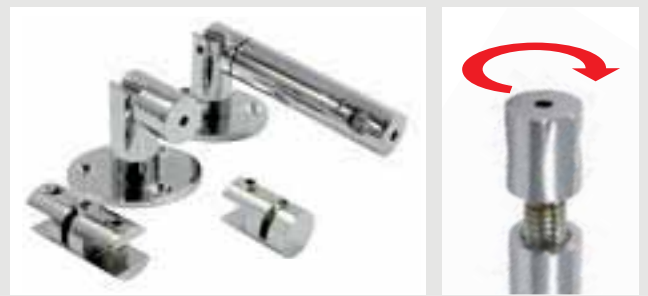

\* Acrylic Pockets at this page are available but not included

## WIRE CABLE Ø 1mm

### CABLE DETAIL



Roll of wire cable suitable for Cablekit systems. With a diameter of Ø1mm and a length of 25m. This hanging wire cable provides tension and firmness to the displaying of pockets.

Ø1 CABLE	LENGTH	Ø WIRE
12.121	25m	1mm

## WIRE CABLE Ø 1.5mm

### CABLE DETAIL



Roll of wire cable suitable for Cablekit systems. With a diameter of Ø1.5mm and a length of 25m. This hanging wire cable provides tension and firmness to the displaying of pockets.

Ø1.5 CABLE	LENGTH	Ø WIRE
12.315	25m	1.5mm

## WIRE CABLE Ø 3mm

### CABLE DETAIL



Roll of wire cable suitable for Cablekit systems. With a diameter of Ø3mm and a length of 25m. This hanging wire cable provides tension and firmness to the displaying of pockets.

Ø3 CABLE	LENGTH	Ø WIRE
12.311	25m	3mm

## ACRYLIC POCKET

### POCKET DETAILS

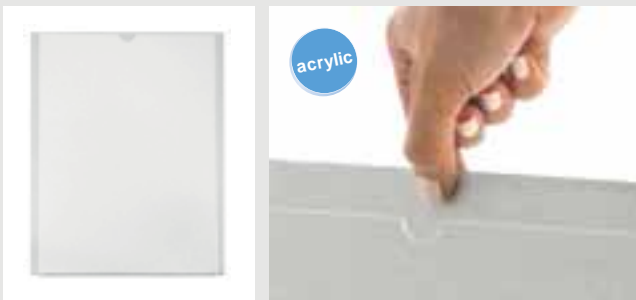

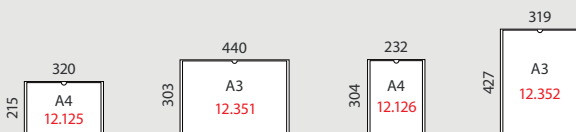

### INFORMATION

\*mm



This transparent 2mm acrylic Pocket folder features 2 formats with 2 orientations.

POCKET	STANDARD FORMATS				
12.125	A4 Horizontal	x10			
12.351	A3 Horizontal	x10			
12.126	A4 Vertical	x10			
12.352	A3 Vertical	x10			

## EPSILON SYSTEM



## STAND DETAILS



12.354 FREE STANDING      KIT CONTENT      \*mm

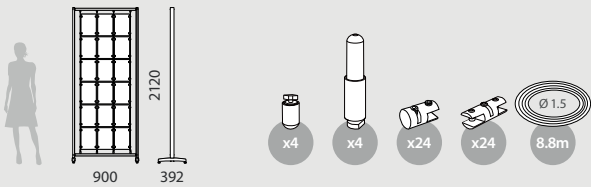

12.355 FREE STANDING      KIT CONTENT      \*mm

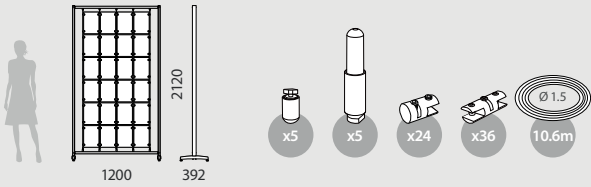

12.356 FREE STANDING      KIT CONTENT      \*mm

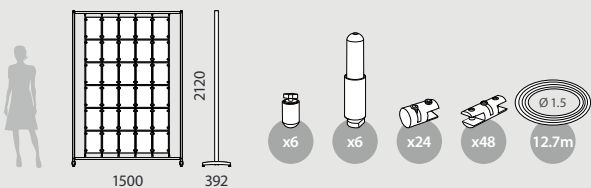

## INFORMATION

The Free Standing is a cable support system for aluminum frame with feet and levelers. Featuring 3 different models. Every kit of Free Standing includes: 1 aluminium Framework, Top connectors, Bottom connectors, Single pocket clips, Double pocket clips and Ø1.5mm cable. Acrylic pockets not included.

FREE STANDING	OUTER SIZE
12.354	900x2120x392mm
12.355	1200x2120x392mm
12.356	1500x2120x392mm

## FREE STANDING



\* Acrylic Pockets at this page are available but not included

## POCKET DETAILS





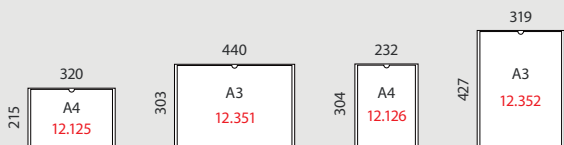





## FORMATS \*mm



## INFORMATION

These transparent Pocket folders are made of 2mm acrylic thickness and 2 sizes are available (A3 and A4). It features an easy and simple graphic change. Also, portrait and landscape orientation of both sizes are available. These holder pockets can be used in a wide range of ways so users can create their own display based on their needs.

POCKET	STANDARD FORMATS				
12.125	A4 Horizontal	x10			
12.351	A3 Horizontal	x10			
12.126	A4 Vertical	x10			
12.352	A3 Vertical	x10			

## ACRYLIC POCKET



\* Cable kits at this page are available but not included

LIGHTBOX DETAILS



DIMENSIONS ARTWORK \*mm

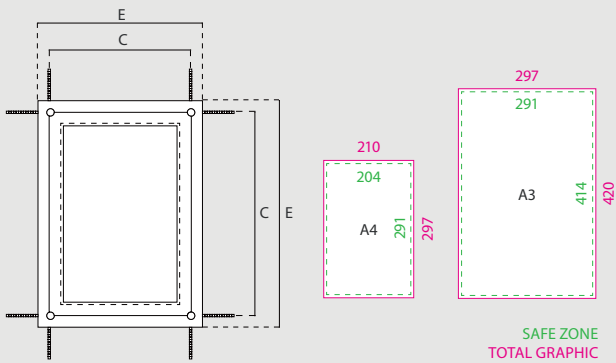

LIGHTBOX SIZE	E (EXTERNAL)	C (CABLE DISTANCE)	BRIGHTNESS	VOLTAGE	POWER
A4	276x363mm	240x327mm	≥ 1500LUX	12V	4.8W
A3	363x486mm	327x450mm	≥ 1500LUX	12V	9.6W

INFORMATION

Light Boxes use 12V safe power and ultra bright LED lights and they are suitable for being used with any of the CableKit systems. Light Boxes feature a magnetic sealed design which makes it easy and fast to change the graphics. Compatible up to Ø1.5mm cable, these holder boxers can be used in a wide range of ways so users can create their own light display based on their needs. It features 2 formats (A4 and A3) with double sided format. The Kit Power Supply and its Power Connector are supplied separately. Ideal for being used on showcases, art exhibitions, storefronts, restaurants, hotels, banks, travel agencies, etc...

DOUBLE A4	QTY	N.W	G.W	C.B.M	SIZE
Packing	2	2.1kg	2.5kg	0.121	410x330x90mm
		Graphic size		External size	
12.550	2	Sided A4		363x276x8mm	x2 

DOUBLE A3	QTY	N.W	G.W	C.B.M	SIZE
Packing	2	3.5kg	4kg	0.02	550x410x90mm
		Graphic size		External size	
12.551	2	Sided A3		486x363x8mm	x2 

LIGHT BOX



## KIT POWER SUPPLY FOR LIGHT BOX

### POWER SUPPLY DETAILS

### KIT INCLUDES

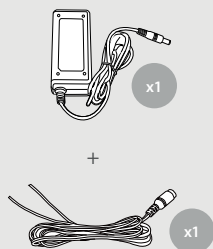

### INFORMATION

Supply Kit has 12V safe power and contains 1 Power Cord and 1 Connector cable.

POWER SUPPLY	POWER	CABLE LENGTH
12.552	12V 2A	2.5+1.5m

## POWER CONNECTOR FOR LIGHT BOX

### CONNECTORS DETAILS

### SIZE

\*mm



Ø 12

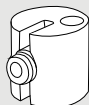

### INFORMATION

These Power Connectors join the LED Lightboxes with the tension wire cable.

CONNECTOR	SIZE
12.553	Ø12x12mm x4 

## FOR ANY CABLEKIT SYSTEM AVAILABLE

### CABLE KIT DETAILS



### INFORMATION

Light Boxes are suitable for being used with any of our CableKit systems.

## WIRE CABLE

### CABLE DETAILS

### INFORMATION



Roll of wire cable suitable for Cablekit systems, with a length of 25m. 2 diameters available: Ø1mm and Ø1.5mm.

WIRE CABLE	LENGTH	Ø WIRE
12.121	25m	1mm
12.315	25m	1.5mm

## LIGHT BOX

