

POP UP DETAILS

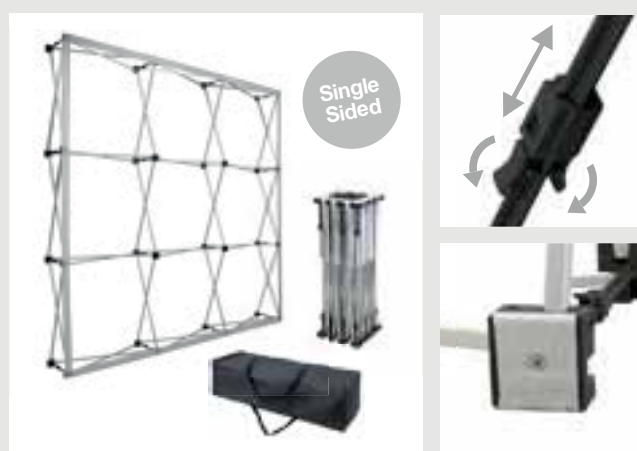

TEXTIL POP UP INSTALATION

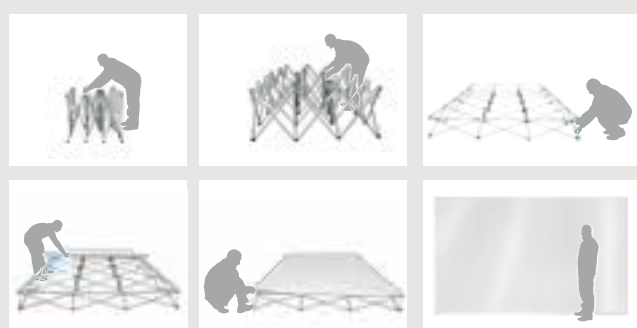

DIMENSIONS

*mm

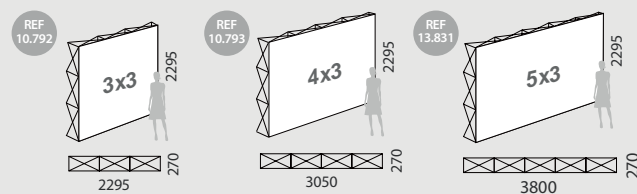

INFORMATION

Ipanema Pop-Up features an aluminium frame with locking arms for an easy assemble. Includes 1 soft-case nylon carry bag and 1 roll of genuine VELCRO® brand fasteners for attachment. This straight fabric Pop-Up is one of the most used options for photocalls. The graphics are simple to attach using the brand fasteners in its perimeter. Ideal for promotional acts, weddings, photocalls or at any stand booth.

IPANEMA 3x3	QTY	N.W	G.W	C.B.M	SIZE
Packing	1	7.65kg	8.35kg	0.06	855x235x280mm
10.792	3x3 Graphic Size: 2295x2295mm				
IPANEMA 4x3	QTY	N.W	G.W	C.B.M	SIZE
Packing	1	8.65kg	9.35kg	0.06	855x235x280mm
10.793	4x3 Graphic Size: 3050x2295mm				
IPANEMA 5x3	QTY	N.W	G.W	C.B.M	SIZE
Packing	1	11.6kg	13.2kg	0.07	830x220x380mm
13.831	5x3 Graphic Size: 3800x2295mm				



IPANEMA POP UP



* VELCRO® is a registered trademark of Velcro BVBA. | VELCRO® est une marque déposée de Velcro Industries B.V. | VELCRO® é uma marca registrada de Velcro Industries B.V. | VELCRO® es una marca registrada de VelcroIndustries B.V.

POP UP DETAILS



DIMENSIONS

*mm

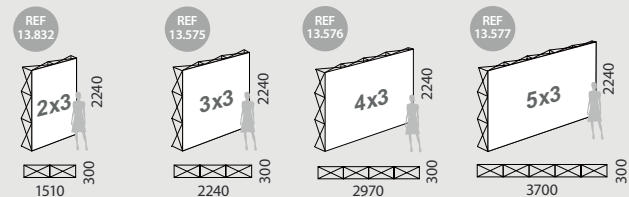

INFORMATION

Surat offers the possibility to fix the graph in the sides of the PopUp (consult the size of the graphics in these cases). Includes 1 soft-case nylon carry bag and 1 roll of genuine VELCRO® brand fasteners for attachment. Surat series feature leveling feet for a suitable adjustment of the PopUp on the surface of the floor.

SURAT 2X3	QTY	N.W	G.W	C.B.M	SIZE
Packing	1	9kg	10kg	0.0747	300x300x830mm
13.832	2x3 Graphic Front: 1510x2240mm Graphic (Front + Sides): 2110x2240mm				
SURAT 3X3	QTY	N.W	G.W	C.B.M	SIZE
Packing	1	9kg	10kg	0.0597	850x260x270mm
13.575	3x3 Graphic Front: 2240x2240mm Graphic (Front + Sides): 2840x2240mm				
SURAT 4X3	QTY	N.W	G.W	C.B.M	SIZE
Packing	1	11kg	12kg	0.0707	850x260x320mm
13.576	4x3 Graphic Front: 2970x2240mm Graphic (Front + Sides): 3570x2240mm				
SURAT 5X3	QTY	N.W	G.W	C.B.M	SIZE
Packing	1	13kg	14kg	0.0774	850x260x350mm
13.577	5x3 Graphic Front: 3700x2240mm Graphic (Front + Sides): 4300x2240mm				



SURAT POP UP



POP UP DETAILS



POP UP DETAILS



DIMENSIONS

*mm

REF 10.413

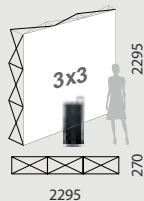

REF 10.414

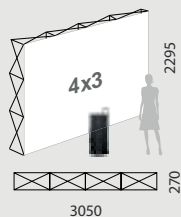

INFORMATION

Cangas Pop-Up is 5 sizes available, featuring an aluminium frame with locking arms for an easy assemble. It includes a trolley Carry Bag and 1 roll of genuine VELCRO® brand fasteners. This straight fabric Pop-Up is one of the most used options for photocalls. The graphics are simple to attach using the brand fasteners in its perimeter. Ideal for promotional acts, weddings, or just for displaying at any stand booth on media events.

CANGAS 3x3	QTY	N.W	G.W	C.B.M	SIZE
Packing	1	13.2kg	15kg	0.2	450x450x950mm
10.413	3x3 Graphic Size: 2295x2295mm				

CANGAS 4x3	QTY	N.W	G.W	C.B.M	SIZE
Packing	1	16.35kg	17.95kg	0.2	450x450x950mm
10.414	4x3 Graphic Size: 3050x2295mm				

CANGAS POP UP



* Spotlights at this page are available but not included



* VELCRO® is a registered trademark of Velcro BVBA. | VELCRO® est une marque déposée de Velcro Industries B.V. | VELCRO® é uma marca registrada de Velcro Industries B. V. | VELCRO® es una marca registrada de VelcroIndustries B. V.

POP UP DETAILS



POP UP DETAILS



DIMENSIONS

*mm

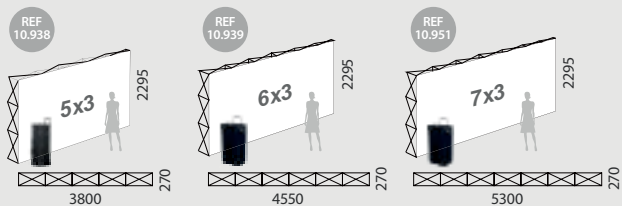

INFORMATION

This straight Textil Pop Up is one of the most used options for phocalls. The model 10.951 is the biggest (2.3x5.3m) Textile Pop Up available. It includes a trolley Carry Bag with wheels and 1 roll of genuine VELCRO® brand fasteners.

CANGAS 5x3	QTY	N.W	G.W	C.B.M	SIZE
Packing	1	16.95kg	18.3kg	0.201	460x460x950mm
10.938	5x3 Graphic Size: 3800x2295mm				
CANGAS 6x3	QTY	N.W	G.W	C.B.M	SIZE
Packing	1	20.50kg	21.9kg	0.201	540x400x950mm
10.939	6x3 Graphic Size: 4550x2295mm				
CANGAS 7x3	QTY	N.W	G.W	C.B.M	SIZE
Packing	1	22.65kg	24.5kg	0.201	540x400x950mm
10.951	7x3 Graphic Size: 5300x2295mm				

CANGAS POP UP



* Spotlights at this page are available but not included



* VELCRO® is a registered trademark of Velcro BVBA. | VELCRO® est une marque déposée de Velcro Industries B.V. | VELCRO® é uma marca registrada de Velcro Industries B.V. | VELCRO® es una marca registrada de VelcroIndustries B.V.

POP UP DETAILS



POP UP INSTALLATION

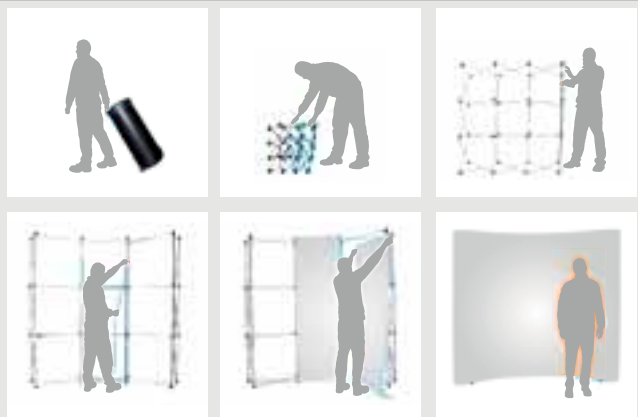

DIMENSIONS

*mm

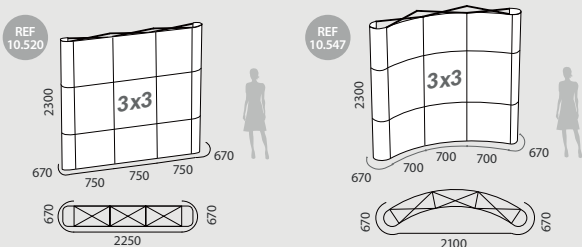

INFORMATION

Laredo 3x3 Pop Up features a straight or curved brushed aluminum frame that is lightweight, yet sturdy. Custom graphics attach to the frame with magnetic loop strips, yet with adhesive to the magnetic strip (1 strip roll is included). Also, 1 nylon trolley carry bag with wheels is included. This portable Pop Up can be set up and taken down in a few minutes. Ideal for enhancing your business's presence at your next media event, exhibition, tradeshow or convention.

3x3 STRAIGHT	QTY	N.W	G.W	C.B.M	SIZE
Packing	1	17.15kg	18.6kg	0.12	390x340x920mm
10.520	Graphic Size:		670x2300mm x2 750x2300mm x3		
3x3 CURVED	QTY	N.W	G.W	C.B.M	SIZE
Packing	1	17.15kg	18.6kg	0.12	390x340x920mm
10.547	Graphic Size:		670x2300mm x2 700x2300mm x3		

LAREDO 3x3



* Spotlights at this page are available but not included



* Spotlights at this page are available but not included

POP UP DETAILS

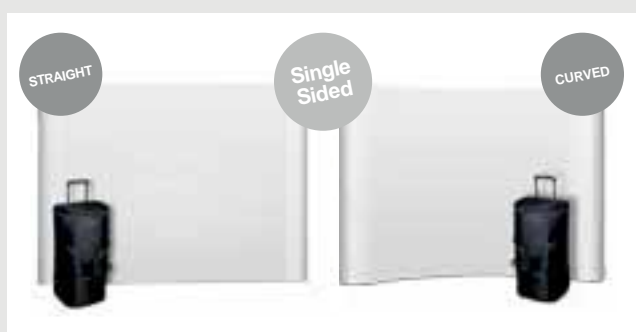

POP UP DETAILS



DIMENSIONS

*mm

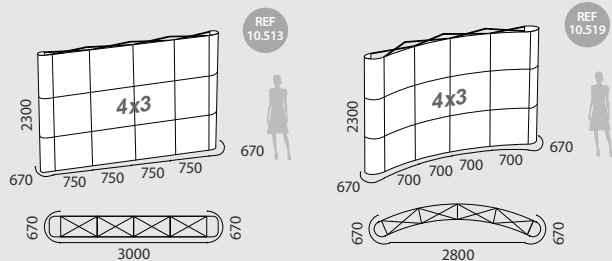

INFORMATION

Laredo 4x3 Pop Up features a straight or curved brushed aluminum frame that is lightweight, yet sturdy. Custom graphics attach to the frame with magnetic loop strips, yet with adhesive to the magnetic strip (1 strip roll is included). Also, 1 nylon trolley carry bag with wheels is included. This portable Pop Up can be set up and taken down in a few minutes. Ideal for enhancing your business's presence at your next media event, exhibition, tradeshow or convention.

4x3 STRAIGHT	QTY	N.W	G.W	C.B.M	SIZE
Packing	1	21.7kg	22.1kg	0.12	390x340x920mm
10.513	Graphic Size:		670x2300mm x2 750x2300mm x4		
4x3 CURVED	QTY	N.W	G.W	C.B.M	SIZE
Packing	1	21.7kg	22.1kg	0.12	390x340x920mm
10.519	Graphic Size:		670x2300mm x2 700x2300mm x4		

LAREDO 4x3



* Spotlights at this page are available but not included



* Spotlights at this page are available but not included

POP UP DETAILS



POP UP INSTALATION

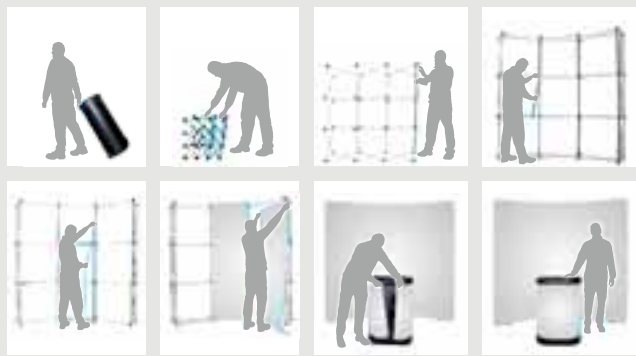

DIMENSIONS

*mm

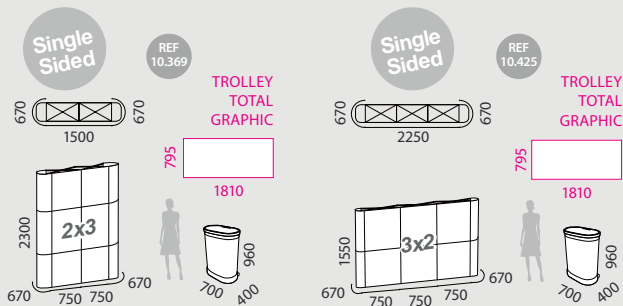

INFORMATION

Madrigal portable Pop Up features a 2x3 or 3x2 brushed aluminum frame that is lightweight, yet sturdy. Custom graphics attach to the frame with magnetic loop strips, yet with adhesive to the magnetic strip (1 strip roll is included). With 2 spotlights, also it includes 1 trolley hard-case with wheels that can be used as a customizable counter (printing is available but not included). Ideal for enhancing your business's presence at your next media event, exhibition, tradeshow or convention.

MADRIGAL 2x3	QTY	N.W	G.W	C.B.M	SIZE
Packing	1	29.4kg	32.6kg	0.32	730x430x1010mm
10.369	Graphic Size:		670x2300mm x2 750x2300mm x2		

MADRIGAL 3x2	QTY	N.W	G.W	C.B.M	SIZE
Packing	1	28.8kg	32kg	0.32	720x430x1010mm
10.425	Graphic Size:		670x1550mm x2 750x1550mm x3		

MADRIGAL 2x3 | 3x2
STRAIGHT

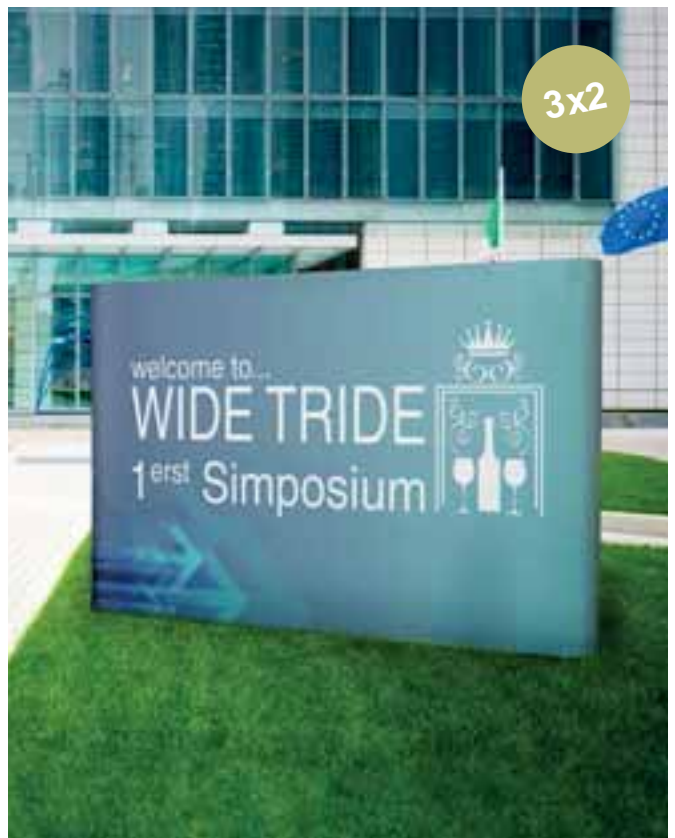

POP UP DETAILS



STRAIGHT



DIMENSIONS

*mm

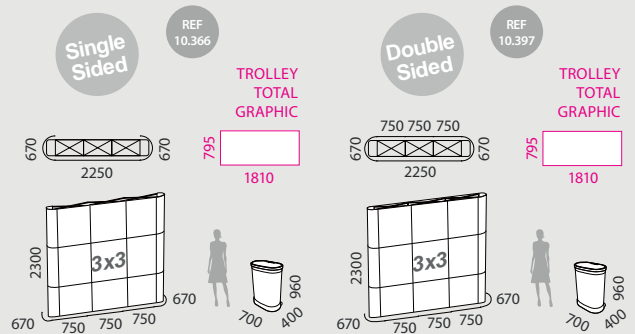

INFORMATION

Madrigal portable 3x3 Straight Pop Up features a brushed aluminum frame which is single-sided or double sided available. Custom graphics attach to the frame with magnetic loop strips, yet with adhesive to the magnetic strip (1 strip roll is included). With 2 spotlights, also it includes 1 trolley hard-case with wheels that can be used as a customizable counter (printing is available but not included). Ideal for enhancing your business's presence at your next media event, exhibition, tradeshow or convention.

3x3 1 SIDE S	QTY	N.W	G.W	C.B.M	SIZE
Packing	1	32.25kg	35.45kg	0.32	730x430x1010mm
10.366	Graphic Size:		670x2300mm x2 750x2300mm x3		

3x3 2 SIDES S	QTY	N.W	G.W	C.B.M	SIZE
Packing	1	34.75kg	37.95kg	0.32	730x430x1010mm
10.397	Graphic Size:		670x2300mm x2 750x2300mm x6		

MADRIGAL 3x3
STRAIGHT



POP UP DETAILS

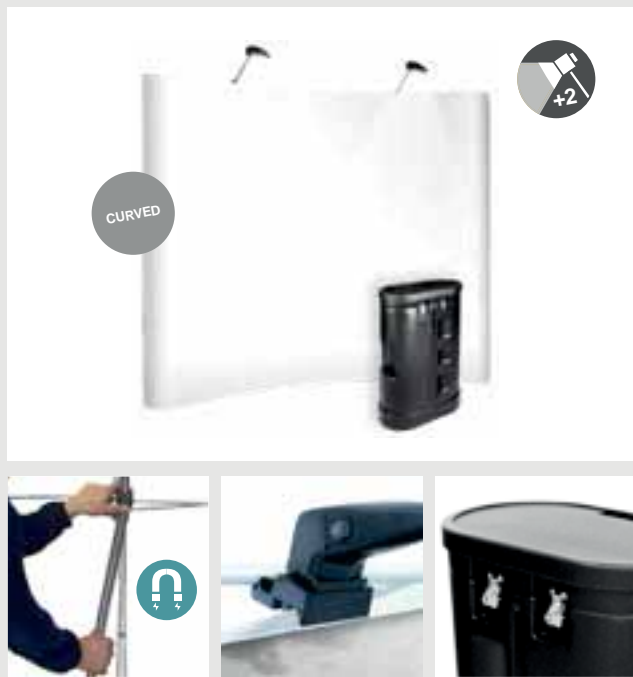

DIMENSIONS

*mm

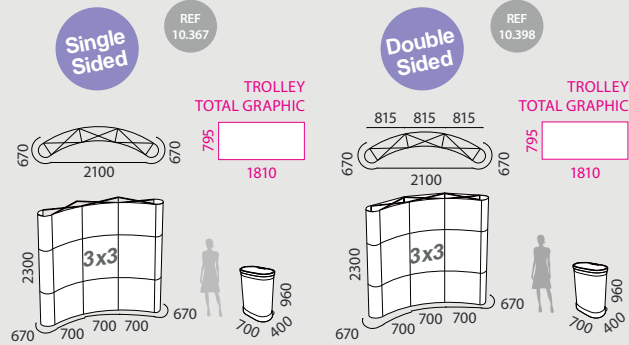

INFORMATION

Madrigal portable 3x3 Curved Pop Up features a brushed aluminum frame which is single-sided or double sided available. Custom graphics attach to the frame with magnetic loop strips, yet with adhesive to the magnetic strip (1 strip roll is included). With 2 spotlights, also it includes 1 trolley hard-case with wheels that can be used as a customizable counter (printing is available but not included). Ideal for enhancing your business's presence at your next media event, exhibition, tradeshow or convention.

3x3 1 SIDE C	QTY	N.W	G.W	C.B.M	SIZE
Packing	1	32.25kg	35.45kg	0.32	730x430x1010mm
10.367	Graphic Size:		670x2300mm x2 700x2300mm x3		

3x3 2 SIDES C	QTY	N.W	G.W	C.B.M	SIZE
Packing	1	34.75kg	37.95kg	0.32	730x430x1010mm
10.398	Graphic Size:		670x2300mm x2 700x2300mm x3 815x2300mm x3		

MADRIGAL 3x3
CURVED



POP UP DETAILS



DIMENSIONS

*mm

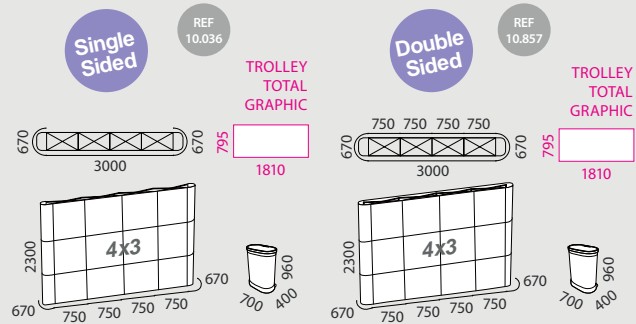

INFORMATION

Madrigal portable 4x3 Straight Pop Up features a brushed aluminum frame which is single-sided or double sided available. Custom graphics attach to the frame with magnetic loop strips, yet with adhesive to the magnetic strip (1 strip roll is included). With 2 spotlights, also it includes 1 trolley hard-case with wheels that can be used as a customizable counter (printing is available but not included). Ideal for enhancing your business's presence at your next media event, exhibition, tradeshow or convention.

4x3 1 SIDE S	QTY	N.W	G.W	C.B.M	SIZE
Packing	1	36.3kg	39.5kg	0.32	730x430x1010mm
10.036	Graphic Size:		670x2300mm x2 750x2300mm x4		

4x3 2 SIDES S	QTY	N.W	G.W	C.B.M	SIZE
Packing	1	44.5kg	47.7kg	0.32	730x430x1010mm
10.857	Graphic Size:		670x2300mm x2 750x2300mm x8		

MADRIGAL 4x3 STRAIGHT



POP UP DETAILS



DIMENSIONS

*mm

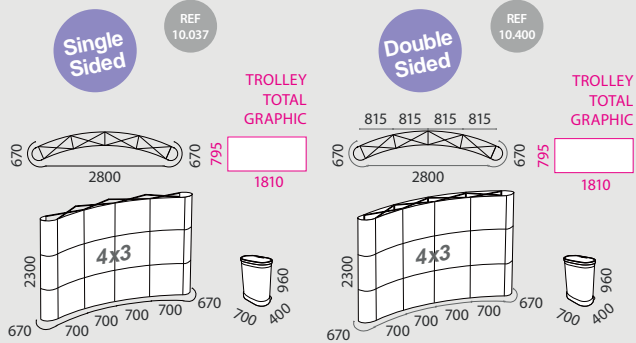

INFORMATION

Madrigal portable 4x3 Curved Pop Up features a brushed aluminum frame which is single-sided or double sided available. Custom graphics attach to the frame with magnetic loop strips, yet with adhesive to the magnetic strip (1 strip roll is included). With 2 spotlights, also it includes 1 trolley hard-case with wheels that can be used as a customizable counter (printing is available but not included). Ideal for enhancing your business's presence at your next media event, exhibition, tradeshow or convention.

4x3 1 SIDE C	QTY	N.W	G.W	C.B.M	SIZE
Packing	1	36.3kg	39.5kg	0.32	710x430x1010mm
10.037	Graphic Size:		670x2300mm x2 700x2300mm x4		

4x3 2 SIDES C	QTY	N.W	G.W	C.B.M	SIZE
Packing	1	44.5kg	47.7kg	0.32	710x430x1010mm
10.400	Graphic Size:		670x2300mm x2 700x2300mm x4 815x2300mm x4		

MADRIGAL 4x3 CURVED



POP UP DETAILS



DIMENSIONS

*mm

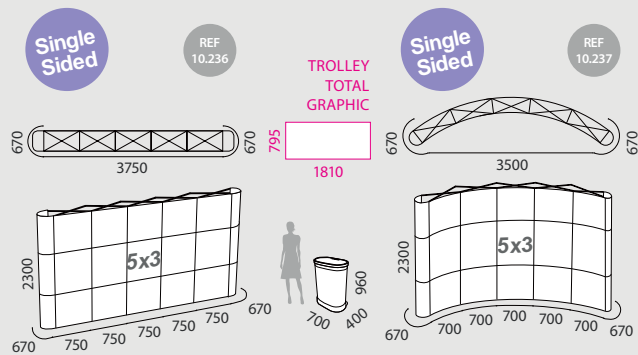

INFORMATION

Madrigal portable 5x3 Pop Up features a brushed aluminum frame which is straight shaped or curved shaped available. Custom graphics attach to the frame with magnetic loop strips, yet with adhesive to the magnetic strip (1 strip roll is included). With 2 spotlights, also it includes 1 trolley hard-case with wheels that can be used as a customizable counter (printing is available but not included). Ideal for enhancing your business's presence at your next media event, exhibition, tradeshow or convention.

5x3 STRAIGHT	QTY	N.W	G.W	C.B.M	SIZE
Packing	1	40.1kg	43.3kg	0.32	730x430x1010mm
10.236	Graphic Size:		670x2300mm x2 750x2300mm x5		

5x3 CURVED	QTY	N.W	G.W	C.B.M	SIZE
Packing	1	40.1kg	43.3kg	0.32	730x430x1010mm
10.237	Graphic Size:		670x2300mm x2 700x2300mm x5		

MADRIGAL 5x3



POP UP DETAILS

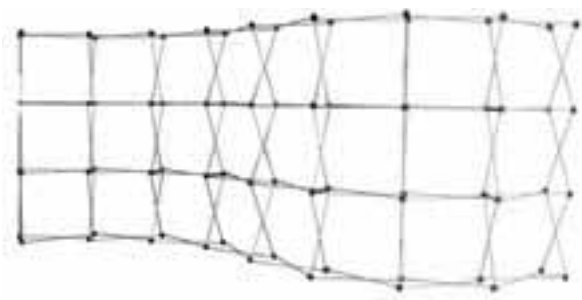

DIMENSIONS

*mm

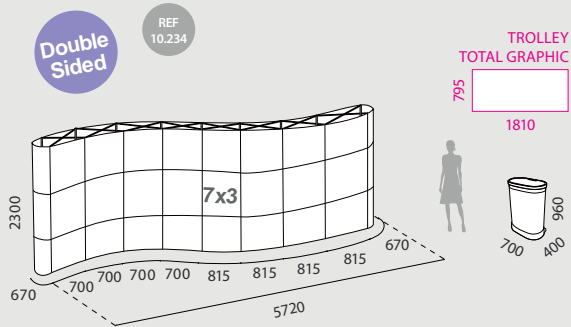

INFORMATION

Teide 8x3 double sided display is the biggest Pop Up, featuring a brushed aluminum frame. Custom graphics attach to the frame with magnetic loop strips, yet with adhesive to the magnetic strip (1 strip roll is included). With 4 spotlights for accenting your graphics. Also, it includes 2 trolley hard-cases with wheels that can be used as counters, and wraps for the cases can be customized with printed graphics (printing is available but not included). Ideal for enhancing your business's presence at your next media event, exhibition, tradeshow or convention.

TEIDE S	QTY	N.W	G.W	C.B.M	SIZE
Packing	2	35.6kg 30kg	36.6kg 31kg	0.32 0.32	730x430x1010mm 730x430x1010mm
10.234	Graphic Size:		670x2300mm x2 700x2300mm x8 815x2300mm x8		

TEIDE 8x3

Biggest Pop-Up



POP UP ACCESSORIES Trolleys and Cases | Table Top

ESCALONA SOFT-CASE TROLLEY



INFORMATION

Made of Nylon with closures and zippers, 2 handle straps, 1 extendable handle and wheels. Escalona is ideal for protecting and transporting Pop Ups.

ESCALONA	QTY	N.W	G.W	C.B.M	SIZE
Packing	1	15kg	18.6kg	0.12	680x170x1030mm
10.060	Trolley Size: 420x420x790mm				

NOVES HARD-CASE TROLLEY



INFORMATION

Made of hard PVC, design lasts through long-term uses. Includes high-quality clasps and rubber wheels. Ideal for being labelled and used as counter.

NOVES	QTY	N.W	G.W	C.B.M	SIZE
Packing	1	7kg	9.1kg	0.18	410x430x1000mm
10.059	Graphic size for Counter: 1450x745mm				

MAQUEDA TROLLEY HARD-CASE



INFORMATION

Made of hard PVC, design lasts through long-term uses. Includes high-quality clasps, rubber wheels and handles. Ideal for carrying case makes easy to transport your trade show accessories and exhibits in between events.

MAQUEDA	QTY	N.W	G.W	C.B.M	SIZE
Packing	1	13kg	15.2kg	0.32	710x420x1010mm
10.058	Trolley: 700x400x960mm Graphic: 1810x795mm				

TABLE TOP FOR POP UP



INFORMATION

Includes nylon carry bag with ID Pocket and handles. Black or Silver color available. Foldable for transportation. Ideal to consolidate your trolley as a promotional counter, providing more surface to display in your event presentation.

TABLE TOP	QTY	N.W	G.W	C.B.M	SIZE
Uni.	1	4.2kg	5.0kg	0.05	830x270x220mm
10.309	785x480x16mm				
10.310					

TROLLEY SOFT-CASE



INFORMATION

Trolley made of black nylon with closures and zippers, 2 handle straps, 1 extendable handle and wheels.

TROLLEY S.C.1	QTY	N.W	G.W	C.B.M	SIZE
Packing	1	3.75kg	5.7kg	0.13	455x265x1160mm
13.456	420x230x1080mm				

TROLLEY SOFT-CASE



INFORMATION

Trolley made of black nylon with closures and zippers, 2 handle straps, 1 extendable handle and wheels.

TROLLEY S.C.2	QTY	N.W	G.W	C.B.M	SIZE
Packing	1	4.15kg	5.5kg	0.12	440x340x820mm
13.457	420x275x670mm				

* Counter is not included / Présentoir non inclus / Balcão não incluídos / Mostrador no incluido.

* Counter is not included / Présentoir non inclus / Balcão não incluídos / Mostrador no incluido.

TOP AND BOTTOM BAR GRAPHIC (3x3)

- EN Top and bottom bars pack for Pop Up 3x3.
- FR Kit de bandes de suspension pour Pop Up 3x3.
- PT Kit de tiras de suspensão para Pop Up 3x3.
- ES Pack de Perchas/Zócalos para Pop Up 3x3.



INFORMATION 3x3 Pop Ups

- Available Pack of 10 bars for **Straight 3x3 Pop Up** (5 Bottom and 5 Top).
- Available Pack of 6 bars for **Back curved 3x3 Pop Up** (3 Bottom and 3 Top).
- Available Pack of 10 bars for **Front curved 3x3 Pop Up** (5 Bottom and 5 Top).

STRAIGHT BAR	QTY	N.W	G.W	C.B.M	SIZE
Packing	10	0.68kg	0.7kg	0.0008	55x20x750mm
10.714	Straight 3x3		Pack: 5 Bottom + 5 Top		

C.FRONT BAR	QTY	N.W	G.W	C.B.M	SIZE
Packing	10	0.7kg	0.72kg	0.0007	55x20x700mm
10.715	Curved/Front 3x3		Pack: 5 Bottom + 5 Top		

C.BACK BAR	QTY	N.W	G.W	C.B.M	SIZE
Packing	6	0.46kg	0.48kg	0.0004	55x10x810mm
10.491	Curved/Back 3x3		Pack: 3 Bottom + 3 Top		

TOP AND BOTTOM BAR GRAPHIC (4x3)

- EN Top and bottom bars pack for Pop Up 4x3.
- FR Kit de bandes de suspension pour Pop Up 4x3.
- PT Kit de tiras de suspensão para Pop Up 4x3.
- ES Pack de Perchas/Zócalos para Pop Up 4x3.

INFORMATION 4x3 Pop Ups

- Available Pack of 12 bars for **Straight 4x3 Pop Up** (6 Bottom and 6 Top).
- Available Pack of 8 bars for **Back curved 4x3 Pop Up** (4 Bottom and 4 Top).
- Available Pack of 12 bars for **Front curved 4x3 Pop Up** (6 Bottom and 6 Top).

STRAIGHT BAR	QTY	N.W	G.W	C.B.M	SIZE
Packing	12	0.83kg	0.85kg	0.0008	55x20x750mm
10.716	Straight 4x3		Pack: 6 Bottom + 6 Top		

C.FRONT BAR	QTY	N.W	G.W	C.B.M	SIZE
Packing	12	0.78kg	0.8kg	0.0007	55x20x700mm
10.717	Curved/Front 4x3		Pack: 6 Bottom + 6 Top		

C.BACK BAR	QTY	N.W	G.W	C.B.M	SIZE
Packing	8	0.6kg	0.62kg	0.0004	55x15x810mm
10.492	Curved/Back 4x3		Pack: 4 Bottom + 4 Top		

MAGNETIC BAR

- EN Magnetic bar. Suitable for models: Laredo, Madrigal and Teide.
- FR Barre magnétique. Compatible avec: Laredo, Madrigal et Teide.
- PT Barra magnética compatível com: Laredo, Madrigal e Teide.
- ES Barra magnética. Válida en modelos: Laredo Madrigal y Teide.



720mm bar for Pop Up

INFORMATION

- See model of Pop Up for compatibility.
- With rail to insert the adhesive magnetic strip.
- Bars for construction of magnetic structures for Pop Ups.

MAGNETIC BAR	QTY	N.W	G.W	C.B.M	SIZE
Packing	1	0.2kg	0.22kg	0.0003	50x10x760mm 
10.419	720mm				

MAGNETIC STRIP ROLL 12mm



- EN Magnetic strip roll, 50 metres length for fixing Pop Up graphics.
- FR Rouleau magnétique de 50m pour la fixation des images au Pop Up.
- PT Rolo magnético com 50 metros para fixar impressões de Pop Up.
- ES Rollo de imán de 50 metros para la fijación de gráficas de Pop Up.

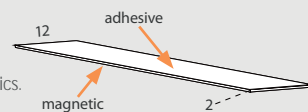

INFORMATION

- 50m Roll.
- 2mm thickness strip.
- One adhesive side for fixing to the graphics.



M.STRIP ROLL	QTY	N.W	G.W	C.B.M	SIZE
Packing	1	3.4kg	3.82kg	0.0038	390x25x390mm  
10.360	50m roll				

POP UP ACCESSORIES Assembly Pieces | PVC Panel

PVC PANNEL FOR POP UPS

EN PVC pannel for Pop Up.
FR Panneau en PVC pour Pop Up.

PT Painel de PVC para Pop Up.
ES Panel de PVC para Pop Up.

INFORMATION

*mm

- Made of 0.4mm white PVC.
- Ideal for printing graphics for Pop Up.

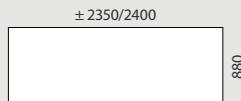

high-quality
white 0.4mm PVC



PVC PANNEL	QTY	N.W	G.W	C.B.M	SIZE
Packing	1	1.15kg	2.5kg	0.015	130x130x890mm
10.101	±2350/2400x880x0.4mm				

CONNECTING PIECES FOR POP UPS



PLASTIC PIECE FOR MAGNETIC BAR

PLASTIC PIECE FOR POP UP CORNER

PLASTIC PIECE FOR BAR GRAPHICS

*mm

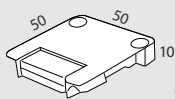

REF 10.858

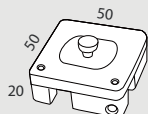

REF 10.409

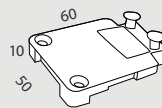

REF 10.859



PIECE M.	QTY	N.W	G.W	C.B.M	SIZE
Packing	1	0.014kg	0.015kg	0.00002	50x10x50mm
10.858	50x50x10mm				

CORNER	QTY	N.W	G.W	C.B.M	SIZE
Packing	1	0.038kg	0.039kg	0.00007	50x30x50mm
10.409	50x50x20mm				

PIECE B.	QTY	N.W	G.W	C.B.M	SIZE
Packing	1	0.02kg	0.021kg	0.00006	55x20x60mm
10.859	60x50x10mm				

CROSS FOR TEXTIL POP UPS



INFORMATION

Cross of replacement for structures on Pop Ups with genuine VELCRO® brand system.

CROSS F.P.U.	QTY	N.W	G.W	C.B.M	SIZE
Packing	1	0.70kg	0.80kg	0.005	80x80x800mm
96.117					

HORIZONTAL CROSS FOR MAGNETIC POP UPS



INFORMATION

One unit cross of replacement for structures on Pop Ups with magnetic system.

HORIZONTAL C.	QTY	N.W	G.W	C.B.M	SIZE
Packing	1	0.70kg	0.80kg	0.005	80x80x800mm
10.897					

* VELCRO® is a registered trademark of Velcro BVBA. | VELCRO® est une marque déposée de Velcro Industries B.V. | VELCRO® é uma marca registrada de Velcro Industries B.V. | VELCRO® es una marca registrada de VelcroIndustries B.V.

SPOTLIGHT DETAILS





INFORMATION

*mm

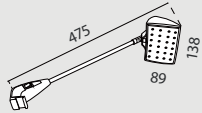
- Clamp base.
- 10W LED light included.
- Ideal for illuminating your exhibit booth and shed light on your displayed products and promotions.



ECONOMIC L.S.	QTY	N.W	G.W	C.B.M	SIZE	
Packing	30	0.3kg	11kg	0.1028	605x515x330mm	
13.753			10 W		18V	

ECONOMIC LED SPOTLIGHT FOR POP UP



SPOTLIGHT FOR POP UP



INFORMATION

*mm

- Double clamp base.
- 150w light included.
- Ideal for illuminating your exhibit booth and shed light on your displayed products and promotional services.

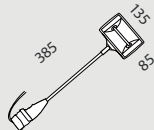

SPOTLIGHT	QTY	N.W	G.W	C.B.M	SIZE
Packing	1	0.65kg	0.7kg	0.0038	150x50x510mm
10.368			150 w		

OXFORD BAG FOR POP UP SPOTLIGHTS

BAG DETAILS



easy transport by handle



INFORMATION

*mm

- Made of black nylon and all crossed zipped.
- The Oxford Bag protects and extends the life of your Pop Up Spotlights. Easy transport by handles.

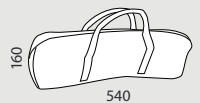

OXFORD BAG	QTY	N.W	G.W	C.B.M	SIZE
Packing	1	0.15kg	0.20kg	0.002	160x30x540mm
13.455					

* Spotlights not included / *Spotlights non inclus / *Focos não incluídos / *Focos no incluídos.

COUNTER DETAILS



COUNTER DETAILS



DIMENSIONS

ARTWORK

*mm

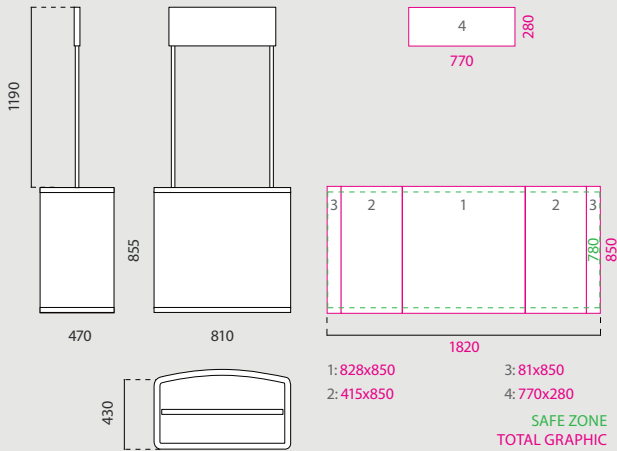

INFORMATION

This counter comes with carry bag and exhibitors can quickly assemble it in a few minutes (no tools required). Once it has been assembled, the counter is lightweight enough to be moved with ease by one person. It has 1 plastic shelf in the interior, so the extra brochures, business cards and flyers can be stored out of sight so your exhibition always appears clean and organized. This counter has a header of 770x280mm for displaying company logos or graphs. Each counter that comes with a header, is excellent for tradeshow and promotional events at stores or business presentations.

TAVIRA



TAVIRA	QTY	N.W	G.W	C.B.M	SIZE
Packing	1	7.35kg	8.95kg	0.073	840x100x880mm
10.098	Total Size Counter: 810x470x2045mm				

COUNTER DETAILS



EXTERNAL SIZE

ARTWORK

*mm

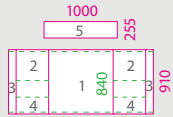
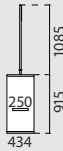
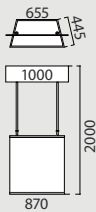

SAFE ZONE
TOTAL GRAPHIC

- 1: 870x910
- 2: 445x435
- 3: 100x910
- 4: 445x240
- 5: 1000x255

INFORMATION

The Salmoral Counter has 1 plastic shelf in the interior of the display for a better storing and it includes a nylon carry bag. This lightweight counter has a header of 1000x255mm for displaying company logos or graphs. Exhibitors can quickly assemble it in less than 5 minutes (no tools required). Excellent for tradeshows and promotional acts at stores, supermarkets or for business presentations.

SALMORAL	QTY	N.W	G.W	C.B.M	SIZE
Packing	1	6.8kg	8.25kg	0.051	560x70x1300mm
10.043	Total Size Counter: 1000x434x2000mm				

SALMORAL



COUNTER DETAIL

EXTERNAL SIZE

ARTWORK

*mm

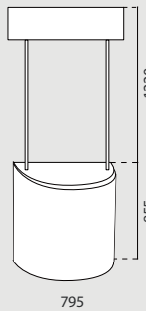

SAFE ZONE
TOTAL GRAPHIC

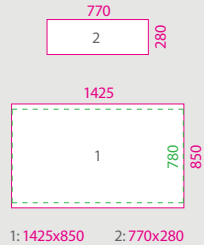

- 1: 1425x850
- 2: 770x280

INFORMATION

This counter comes with carry bag and exhibitors can quickly assemble it in a few minutes (without tools). It has 1 plastic shelf in the interior of the display. Belvis features an accessible semicircular design. This counter has a header of 770x280mm for displaying company logos or graphs. Ideal for tradeshows and promotional events at any stores or business presentations.

BELVIS	QTY	N.W	G.W	C.B.M	SIZE
Packing	1	5.8kg	7.7kg	0.09	860x120x870mm
10.719	Total Size Counter: 795x440x2075mm				

BELVIS

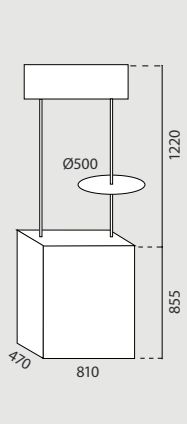

COUNTER DETAIL DIMENSIONS ARTWORK *mm

TOTAL GRAPHIC

770
3 280

4 2 1 2 4 850

1: 824x850 3: 770x280
2: 408x850 4: 115x850

INFORMATION

This counter comes with carry bag and exhibitors can quickly assemble it in a few minutes (no tools required). It has 1 circular Ø500mm shelf for one pole and 1 plastic shelf in the interior of the display. This counter has a header of 770x280mm for displaying company logos or graphs. It is excellent for tradeshows and promotional events at stores or business presentations.

MANCHESTER	QTY	N.W	G.W	C.B.M	SIZE
Packing	1	9.5kg	10.5kg	0.08	860x110x880mm
10.676	Total Size Counter: 810x470x2075mm				

MANCHESTER

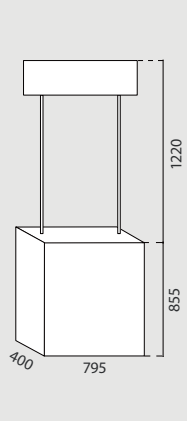

COUNTER DETAIL DIMENSIONS ARTWORK *mm

TOTAL GRAPHIC

770
3 280

4 2 1 2 4 850

1: 824x850 3: 770x280
2: 408x850 4: 115x850

INFORMATION

This counter comes with carry bag and exhibitors can quickly assemble it in less than 5 minutes (no tools required). It has 1 plastic shelf in the interior of the display. Featuring a sleek blacklenned look design, allowing the display to stand out against any background. With a displaying header of 770x280mm, Lake Counter is excellent for tradeshows, stores or business presentations.

LAKE	QTY	N.W	G.W	C.B.M	SIZE
Packing	1	8.5kg	9.5kg	0.08	860x110x880mm
10.675	Total Size Counter: 795x400x2075mm				

LAKE



COUNTER DETAILS



ARTWORK *mm

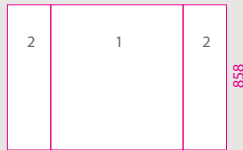
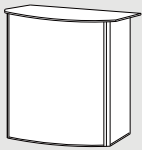

TOTAL GRAPHIC

1: 1004x858
2: 322x858

INFORMATION

This Counter has an aluminium frame and two internal shelves to give the promo stands support and provide storage space. Also it features 2 lockable doors. The top counter shelf has a wooden finish for a durable, yet attractive display. It is assembled and disassembled quickly and stored into a carrying bag.

SIGÜENZA	QTY	N.W	G.W	C.B.M	SIZE
Packing	1	27kg	30kg	0.23	950x200x1250mm
10.493					

SIGÜENZA



COUNTER DETAILS



ARTWORK *mm

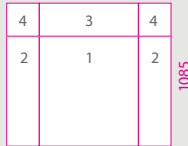
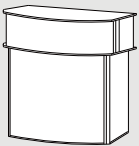

TOTAL GRAPHIC

1: 1004x858 3: 1122x227
2: 322x858 4: 212x227

INFORMATION

The Sepulveda Counter has an aluminium frame and 3 shelves (2 internal) to give the stands support and provide storage space, with third shelf the counter has an added desk. Also features 2 lockable doors. The top counter shelf has a wooden finish. It is assembled and disassembled quickly and stored into a carrying bag

SEPULVEDA	QTY	N.W	G.W	C.B.M	SIZE
Packing	1	36.8kg	41.9kg	0.18	940x160x1190mm
10.494					

SEPULVEDA



COUNTER DETAILS

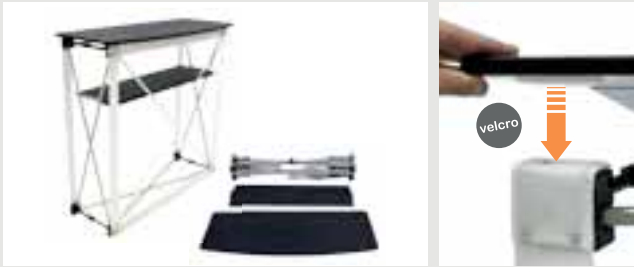

EXTERNAL SIZE

ARTWORK

*mm

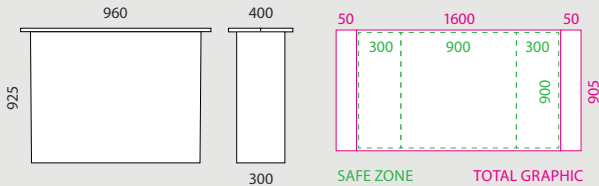

INFORMATION

Ajalvir is a very fast assembly counter thanks to its genuine VELCRO® brand fasteners system. Features 2 blackened wooden shelves (foldable top) and a carry bag. Ideal for tradeshows, promotional events at stores or business presentations.

AJALVIR	QTY	N.W	G.W	C.B.M	SIZE
Packing	1	8.35kg	9.15kg	0.0609	290x210x1000mm
10.323	Graphic Size: 905x1600mm				

AJALVIR



COUNTER DETAILS



EXTERNAL SIZE

ARTWORK

*mm

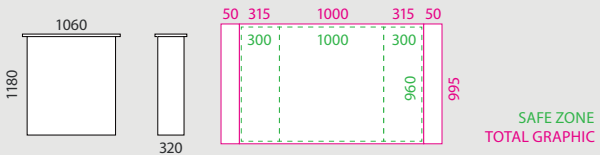

INFORMATION

Villares is a very fast assembly counter thanks to its genuine VELCRO® brand fasteners system. Features 2 blackened wooden shelves (foldable top) and a carry bag. Ideal for tradeshows, promotional events at stores or business presentations.

VILLARES	QTY	N.W	G.W	C.B.M	SIZE
Bottom	1	3.1kg	6.85kg	0.12	445x230x130mm
Top	1	5.45kg	6.6kg	0.04	465x70x120mm
10.096	Graphic Size: 1730x995mm				

VILLARES



COUNTER DETAILS



EXTERNAL SIZE

ARTWORK

*mm

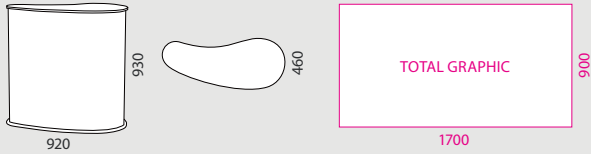

INFORMATION

Cezures counter features a black wooden counter top and base. A carrying bag with handles is included. It can be used to hold promotional materials, also known as a portable stand, can be used to conduct a product demonstration. Easy and fast to set up thanks to its genuine VELCRO® brand fasteners system.

CEZURES	QTY	N.W	G.W	C.B.M	SIZE
Packing	2	7.7kg	12kg	0.02	570x380x940mm
10.686	Graphic Size: 1700x900mm				

CEZURES



COUNTER DETAILS



DIMENSIONS

ARTWORK

*mm

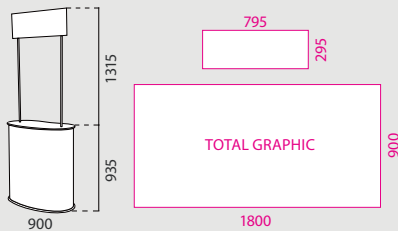

INFORMATION

The Atenas Counter features a black wooden countertop and base. Also, it has 1 plastic shelf in the interior and a top header of 795x295mm for displaying your message. A fabric carrying bag with handles is included. Easy and fast to set up thanks to its genuine VELCRO® brand fasteners system. It is ideal for being used at tradeshows, media events or business presentations.

ATENAS	QTY	N.W	G.W	C.B.M	SIZE
Packing	1	25.8kg	27kg	0.21	500x440x940mm
10.312	Graphic Size: 1800x900mm				

ATENAS



* VELCRO® is a registered trademark of Velcro BVBA. | VELCRO® est une marque déposée de Velcro Industries B.V. | VELCRO® é uma marca registrada de Velcro Industries B.V. | VELCRO® es una marca registrada de Velcro Industries B.V.

COUNTER DETAILS



DIMENSIONS

ARTWORK

*mm

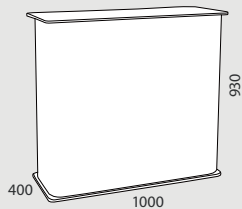

TOTAL GRAPHIC



INFORMATION

This counter comes with carry bag and exhibitors can quickly assemble it in a few minutes (no tools required) thanks to its genuine VELCRO® brand fasteners system. Once it has been assembled, the counter is lightweight enough to be moved with ease by one person. It has 1 shelf in the interior, so the extra brochures, business cards and flyers can be stored out of sight so your exhibition always appears clean and organized. This counter features wood or black finish available. Ideal for tradeshow and promotional events at stores or business presentations.

CAEN	QTY	N.W	G.W	C.B.M	SIZE
Packing	1	16kg	19kg	0.2012	1290x300x520mm

13.845-1  Graphic Size: 2195x900mm

13.845-2  Graphic Size: 2195x900mm

CAEN



* VELCRO® is a registered trademark of Velcro BVBA. | VELCRO® est une marque déposée de Velcro Industries B.V. | VELCRO® é uma marca registrada de Velcro Industries B. V. | VELCRO® es una marca registrada de VelcroIndustries B. V.

COUNTER DETAILS



EXTERNAL SIZE

ARTWORK

*mm

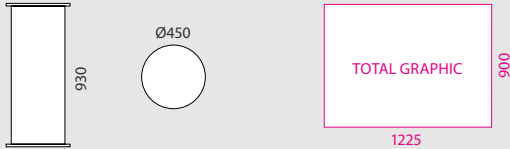

INFORMATION

The Valdes Counter features a circular design that allows the integration of the counter in any space for exhibition and with the advantage of being more accessible than other counters. It has a black wooden countertop and base. It is fast and easy to setup in seconds. A carrying bag with handles is included.

VALDES	QTY	N.W	G.W	C.B.M	SIZE
Packing	2	3.8kg 2.7kg	4.3kg 3.2kg	0.016 0.037	460x80x460mm 200x200x930mm
10.685		Graphic Size: 1225x900mm			

VALDES



COUNTER DETAILS



EXTERNAL SIZE

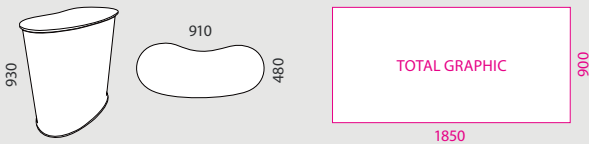

ARTWORK

*mm



INFORMATION

The Doiras Counter features a black wooden countertop and base. Also, it has 1 plastic shelf in the interior for storing. A nylon carrying bag with handles is included. Doiras Counter is easy to set-up and breakdown in only a few seconds, making it perfect for travelling business people.

DOIRAS	QTY	N.W	G.W	C.B.M	SIZE
Packing	2	12kg 1.5kg	13kg 2kg	0.0372 0.0372	500x80x930mm 200x200x930mm
13.475		Graphic Size: 1850x900mm			
13.476					

DOIRAS

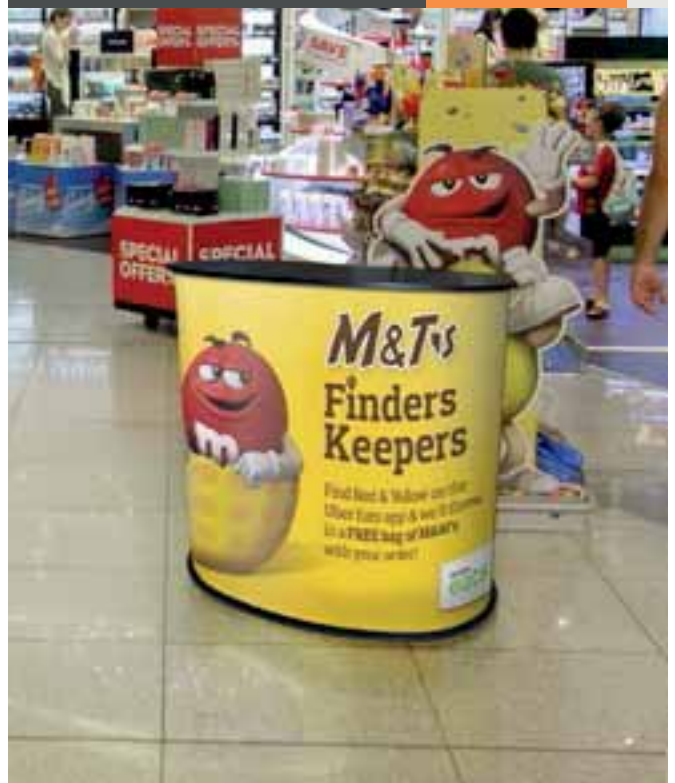

new

COUNTER DETAILS



DOIRAS XXL



DIMENSIONS

ARTWORK

*mm

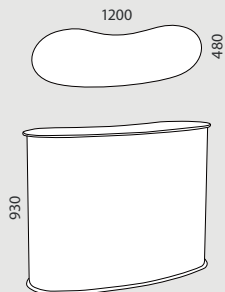

TOTAL GRAPHIC

INFORMATION

Doiras XXL comes with carry bag and exhibitors can quickly assemble it in a few minutes (no tools required) thanks to its genuine VELCRO® brand fasteners system. Once it has been assembled, the counter is lightweight enough to be moved with ease by one person. It has 1 shelf in the interior, so the extra brochures, business cards and flyers can be stored out of sight so your exhibition always appears clean and organized. This counter features wood or black finish available. Ideal for tradeshows and promotional events at stores or business presentations.



CAEN	QTY	N.W	G.W	C.B.M	SIZE
Packing	1	15kg	16kg	0.2126	450x1050x450mm

13.846-1  Graphic Size: 1950x900mm

13.846-2  Graphic Size: 1950x900mm

* Roll Up in 13846-2 example is available but not included. See it in Chapter 1 Displays.

COUNTER DETAILS



DIMENSIONS

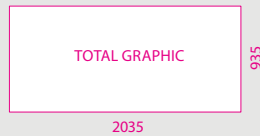
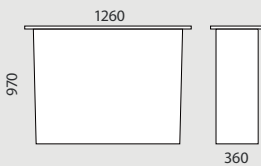

ARTWORK

*mm



INFORMATION

This stylish Promotion Counter is completely portable, functional and has 1 shelf in the interior of the display, so your exhibition always appears clean and organized. Also, There are 3 wooden finishes for the top: black, brown or yellow colored. The curved counter is lightweight and includes two carrying cases. Graphics are really easy to attach to the display thanks its magnetic system. Cebreros counter is ideal for various promotional needs are often used to hold product samples, corporate literature, business cards, brochures and more so counter is perfect for a wide variety of promotional applications, including in-store displays, such as grocery 'free sample' promotions.

CEBREROS 1	QTY	N.W	G.W	C.B.M	SIZE
Bottom	1	7.55kg	9.55kg	0.06	380x160x1030mm
Top	1	6.7kg	8.35kg	0.04	460x110x750mm
10.241		Graphic Size: 2035x935mm			
CEBREROS 2	QTY	N.W	G.W	C.B.M	SIZE
Bottom	1	7.55kg	9.55kg	0.06	380x160x1030mm
Top	1	6.7kg	8.35kg	0.04	460x110x750mm
10.392		Graphic Size: 2035x935mm			
CEBREROS 3	QTY	N.W	G.W	C.B.M	SIZE
Bottom	1	7.55kg	9.55kg	0.06	380x160x1030mm
Top	1	6.7kg	8.35kg	0.04	460x110x750mm
10.042		Graphic Size: 2035x935mm			

CEBREROS



COUNTER DETAILS



*Printed on fabric.
Impression sur toile.
Impressão em tecido.
Impresión en tela.



EXTERNAL SIZE ARTWORK *mm

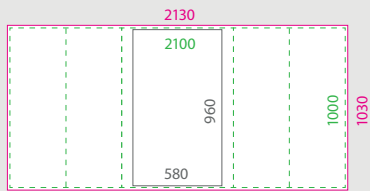
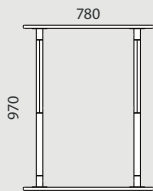

FRONT VIEW
SAFE ZONE
TOTAL GRAPHIC



INFORMATION

These Counters are designed for using with fabric wrap (printed on textile) making it lightweight and easy to fold. Also, the Fabric Counters are also simple to setup. All the aluminium poles fit together and snap into place. Simply stretch the wrap over the completed base and it's ready to use. With carry bag for easy travelling. Features a double zip to the interior of the counter for storing, so your exhibition always appears clean and organized. Baracoa is ideal as a lectern or podium at tradeshow, promotional events or conventions and are great to pair with Pop Up banners or any stand.

BARACOA	QTY	N.W	G.W	C.B.M	SIZE
Packing	1	8kg	9.2kg	0.042	860x120x410mm
13.740	Graphic Size: 2130x1030mm				

BARACOA





COUNTER DETAILS



*Printed on fabric.
Impression sur toile.
Impressão em tecido.
Impresión en tela.



EXTERNAL SIZE

*mm

ARTWORK

DOWNLOAD

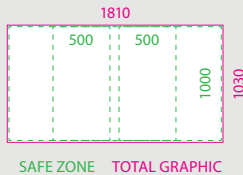

INFORMATION

Creta is lightweight and easy to fold and setup. With carry bag and a single zip to the interior for storing. Features 3 points of view. Ideal as a lectern or podium at tradeshows, events or conventions.

CRETA	QTY	N.W	G.W	C.B.M	SIZE
Packing	1	11kg	12kg	0.04	650x100x650mm
10.311	Graphic Size: 1810x1030mm				

CRETA



COUNTER DETAILS



*Printed on fabric.
Impression sur toile.
Impressão em tecido.
Impresión en tela.

automatic hydraulic



EXTERNAL SIZE

*mm

ARTWORK

DOWNLOAD

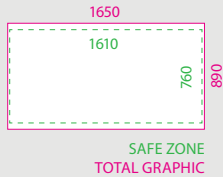
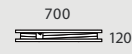
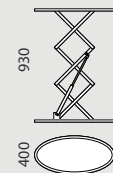

INFORMATION

Sienna is lightweight and easy to fold and setup. With a hard carry padded bag and a double zip. Features an **hydraulic drive system** for an automatic and quick unfolding with just a slight push on the top of the counter. Ideal for events or conventions and are great to pair with Pop Up banners or any stand.

SIENNA	QTY	N.W	G.W	C.B.M	SIZE
Packing	1	5.6kg	7.6kg	0.21	970x600x360mm
15.244	Graphic Size: 1650x890mm				

SIENNA



* Printing is available but not included



COUNTER DETAILS



*Printed on fabric.
Impression sur toile.
Impressão em tecido.
Impresión en tela.



EXTERNAL SIZE

*mm

ARTWORK

DOWNLOAD

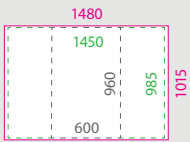
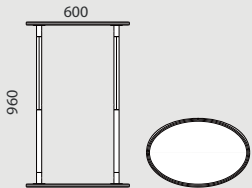

FRONT VIEW SAFE ZONE TOTAL GRAPHIC

INFORMATION

Manacor is lightweight and fast to setup. Features an oval shape design. With carry bag and a double zip to the interior for storing. Ideal as a lectern or podium at tradeshows, events or conventions.

MANACOR	QTY	N.W	G.W	C.B.M	SIZE
Packing	1	7.0kg	7.44kg	0.0366	440x130x640mm
10.318	Graphic Size: 1480x1015mm				

MANACOR



COUNTER DETAILS



*Printed on fabric.
Impression sur toile.
Impressão em tecido.
Impresión en tela.



EXTERNAL SIZE

*mm

ARTWORK

DOWNLOAD

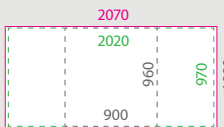
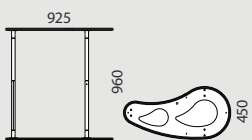

FRONT VIEW SAFE ZONE TOTAL GRAPHIC

INFORMATION

Mahon is lightweight and easy to assembly. Features the classic raindrop shape design. With carry bag and a double zip to the interior for storing. Ideal as a lectern or podium at promotional events, tradeshows, point of sales.

MAHON	QTY	N.W	G.W	C.B.M	SIZE
Packing	1	10.50kg	10.93kg	0.0672	500x140x960mm
10.319	Graphic Size: 2070x1000mm				

MAHON



* Printing is available but not included

CONTENT

EN	Magnetic Panel System. Using straight frames to which the graphic panel can be attached by means of magnetic strips. • 2 round steel bases. • 2 aluminum poles. • 2 spotlights. • Connectors. • 4 aluminum cases (700x1000mm). • 8 pieces of PS of panel.
FR	Système de panneaux magnétiques. Affichage fixé sur cadre avec ruban magnétique. • 2 bases rondes en acier. • 2 poteaux en aluminium. • Connecteurs. • 4 cadres en aluminium (700x1000mm). • 8 pcs de panneau PS. • 2 foyers.
PT	Sistema de painéis magnéticos. Os painéis são fixados nos marcos mediante barras magnéticas. • 2 bases redondas de aço. • 2 postes de alumínio. • 8 peças de painel PS. • 4 marcos de alumínio (700x1000mm). • 2 focos. • Conectores.
ES	Sistema de panel magnético. Usando marcos rectos a los cuales el panel gráfico puede unirse por bandas magnéticas. • 2 bases redondas de acero. • 2 postes de aluminio. • 8 pcs PS panel. • 4 marcos de aluminio (700x1000mm). • 2 focos. • Conectores.

VIDAGO
PANEL BANNER



spotlights included

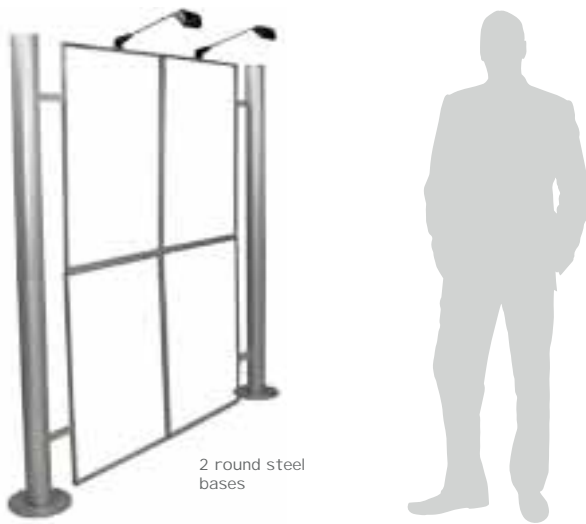

WALL DETAILS



INFORMATION

This exhibition display unit features 1 backdrop double-sided panel designed for 8 graphic panes. This unit can be easily assembled into an appealing pop up display thanks its magnetic system to fix the panes. Aluminium structure composed by 2 poles, 4 cases and 2 round bases made of steel. Also 2 spotlights are included. Pair this backdrop with some trade show fixtures available on this catalogue, such as counters, iPad mounts, chairs or brochure stands. The exhibition booths, offer a great way to market your business at trade shows, conventions, media events and expos.

VIDAGO	QTY	N.W	G.W	C.B.M	SIZE
Packing	1	34.5kg	35kg	0.40	800x400x1250mm
10.430	Graphic Size: 2100x2000mm				

EXTERNAL SIZE

ARTWORK

*mm

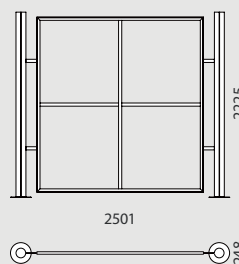

2100

TOTAL GRAPHIC

* Printing is available but not included.

CATANIA

CONTENT

EN

Portable Display Wall. The construction makes an easy and fast assembly.
 • Aluminium Profile, base feet and two spotlights.
 • Oxford Cloth bag: 1 unit.

FR

Display portable, facile et rapide à monter.
 • Profils en aluminium, bases et foyers d'éclairage.
 • Valise de transport Oxford Cloth: 1 unité.

PT

Display portátil de fácil e rápida montagem.
 • Perfis de alumínio, bases e focos.
 • Mala de transporte Oxford Cloth: 1 unidade.

ES

Display portátil de fácil y rápido montaje.
 • Perfil de aluminio, bases y dos focos.
 • Bolsa de transporte: 1 unidad.



spotlights included



1 oxford bag included



WALL DETAILS



INFORMATION

This portable exhibition display unit features a lightweight, yet sturdy, aluminium profile structure. This unit can be easily assembled fast and easily. The entire portable display can be set up and taken down within minutes. It's composed by 1 aluminium frame structure, 2 round bases and 1 oxford bag for an easy transportation. Also 2 spotlights are included. Pair this backdrop wall with some trade show fixtures available on this catalogue, such as counters, iPad mounts, chairs or brochure stands. The exhibition booths, offer a great way to market your business at trade shows, conventions, media events or expos.

EXTERNAL SIZE

*mm

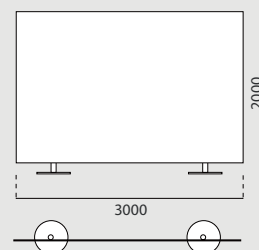

CATANIA	QTY	N.W	G.W	C.B.M	SIZE
Packing	1	15kg	16.2kg	0.14	420x150x1250mm
10.647	Size: 3000x2000mm				

* Printing is available but not included.

PERUGIA

CONTENT

EN

Portable Display Wall. The construction makes an easy and fast assembly.
 • Aluminium Profile, base feet and two spotlights.
 • Oxford Cloth bag: 1 unit.

FR

Visuel portable, facile et rapide à monter.
 • Profils en aluminium, bases et foyers d'éclairage.
 • Valise de transport Oxford Cloth: 1 unité.

PT

Display portátil de fácil e rápida montagem.
 • Perfis de alumínio, bases e focos.
 • Mala de transporte Oxford Cloth: 1 unidade.

ES

Display portátil de fácil y rápido montaje.
 • Perfil de aluminio, bases y dos focos.
 • Bolsa de transporte: 1 unidad.



2 spotlights included



Oxford bag included

INFORMATION

This portable exhibition display unit features a lightweight, yet sturdy, 2x3m aluminium profile structure. This unit can be easily assembled fast and easily. The entire portable display can be set up and taken down within minutes. It's composed by 1 aluminium frame structure, 2 round bases and 1 oxford bag for an easy transportation. Also 2 spotlights are included. Pair this backdrop wall with some trade show fixtures available on this catalogue, such as counters, iPad mounts, chairs or brochure stands. The exhibition booths, offer a great way to market your business at trade shows, conventions, media events or expos.

PERUGIA	QTY	N.W	G.W	C.B.M	SIZE
Packing	1	15kg	16.2kg	0.14	420x150x1250mm
10.648	Graphic Size: 3000x2000mm				

EXTERNAL SIZE

ARTWORK

*mm

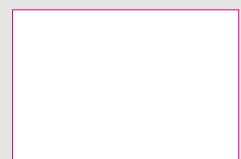
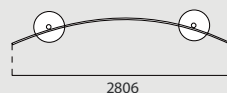

3000

2000

TOTAL GRAPHIC

* Printing is available but not included.

LIMOGES

CONTENT

EN Stable Exhibition System. Fast and easy assembly.
 • Aluminium frame 2000x2200mm.
 • Header Board, Shelves: 1.
 • Wings (2 units) (L&R). • V" Shape Table: 1.
 • Spotlights (2 units). • Plastic Packing Case.

FR Système d'exposition stable. Montage facile.
 • Cadre en aluminium 2000x2200mm.
 • Ailes (2 unités) (L&R).
 • Plaque supérieur Étagère: 1. • "Table en "V": 1.
 • Foyers d'éclairage (2 unités). • Valise en plastique.

PT Sistema de exibição estável. De fácil montagem.
 • Marco de alumínio 2000x2200mm.
 • Placa superior. Prateleira: 1.
 • Alas (2 unidades) (L&R). • Mesa em forma de "V": 1.
 • Focos (2 unidades).
 • Mala de transporte em plástico.

ES Sistema de exhibición estable de fácil montaje.
 • Marco de aluminio 2000x2200mm.
 • Placa superior. Estantes: 1.
 • 2 Alas (izquierda, derecha).
 • Mesa en forma de "V": 1.
 • 2 focos. • Maleta de plástico.



2 spotlights are included



hard case included

INFORMATION

This portable exhibition display unit features a lightweight, yet sturdy, 2x2m aluminium profile structure. This unit can be easily assembled fast and easily. The entire portable display can be set up in a few minutes. It's composed by 1 aluminium frame structure, 2 round bases, 1 header board, 2 sides wings, 1 shelf, 1 "V" table, 2 spotlights and 1 hard case. Pair this backdrop wall with some trade show fixtures available on this catalogue, such as counters, iPad mounts, chairs or brochure stands. The exhibition booths, offer a great way to market your business at trade shows, conventions, media events or expos.

LIMOGES	QTY	N.W	G.W	C.B.M	SIZE
Packing	1	52.5kg	54kg	0.44	780x390x1450mm
10.153					

EXTERNAL SIZE

ARTWORK

*mm

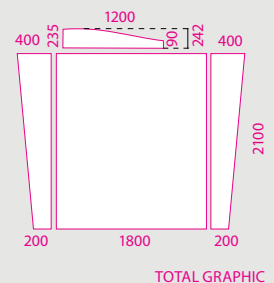
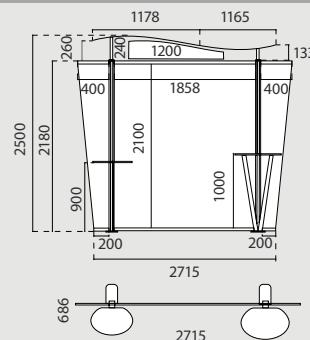

TOTAL GRAPHIC

* Printing is available but not included.

CONTENT

EN	<p>Stable Exhibition System. Easy to be assembled.</p> <ul style="list-style-type: none"> • Aluminium frame 2850x2200mm. • Header Board. Shelves: 3. • Wings (2 units) (L&R). • "V" Shape Table: 1. • Spotlights (3 units). • Plastic Packing Case.
FR	<p>Système d'exposition stable. Montage facile.</p> <ul style="list-style-type: none"> • Cadre en aluminium 2850x2200mm. • Plaque supérieur. Étagères: 3. • Ailes (2 unités) (L&R). • Foyers d'éclairage (3 unités). • Table en "V": 1. • Valise en plastique: 1 unité.
PT	<p>Sistema de exibição estável. De fácil montagem.</p> <ul style="list-style-type: none"> • Marco de alumínio 2850x2200mm. • Placa superior. Prateleiras: 3. • Alas (2 unidades) (L&R). • Mala de transporte em plástico: 1. • Mesa em forma de "V": 1. • Focos (3 unidades). Fixador de LCD.
ES	<p>Sistema de exhibición estable. Fácil montaje.</p> <ul style="list-style-type: none"> • Marco de aluminio 2850x2200mm. • Placa superior. Estantes: 3. • 2 Alas (izquierda, derecha). • Mesa en forma de "V": 1. • 3 focos. • Maleta de plástico.

OPOLE



Includes 3 spotlights



hard case included

INFORMATION

Opole is a portable and elegant exhibition display unit formed by a sturdy, 2850x2200mm aluminium structure. This unit can be easily assembled fast and easily. The entire portable display can be set up in a few minutes. It's composed by 1 aluminium frame structure, 1 header board, 2 sides wings, 3 shelves, 1 "V" table, 3 spotlights and 1 hard case. Pair this backdrop wall with some trade show fixtures available on this catalogue, such as counters, iPad mounts, chairs or brochure stands. The exhibition booths, offer a great way to market your business at trade shows, conventions, media events or expos.

OPOLE	QTY	N.W	G.W	C.B.M	SIZE
Packing	1	63.5kg	65kg	0.441	780x390x1450mm
10.192					

EXTERNAL SIZE

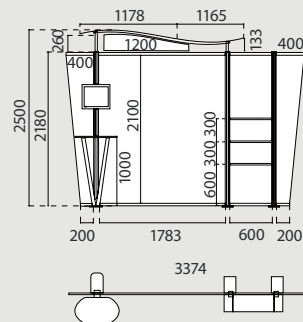

ARTWORK

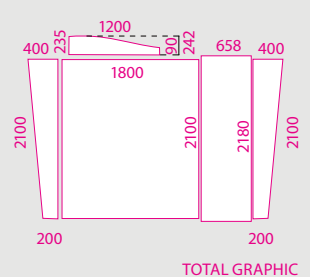

* TV is not included. Printing is available but not included.

KASSEL



includes 3 spotlights



3 shelves included

hard case included



INFORMATION

Kassel is a portable and elegant -All in one- trade show booth unit formed by a sturdy, 2824x2400mm aluminium structure. This unit can be easily assembled fast and easily. The entire portable display can be set up in a few minutes. It's composed by 1 aluminium frame structure, 1 header board, 3 shelves, 1 counter, 3 spotlights and 1 hard case. Pair this tradebooth with some trade show fixtures available on this catalogue, such as Totems, iPad mounts, chairs or brochure stands. The exhibition booths, offer a great way to market your business at trade shows, conventions, media events or expos.

KASSEL	QTY	N.W	G.W	C.B.M	SIZE
Packing	1	85.5kg	86.95kg	0.441	780x390x1450mm
10.364					

EXTERNAL SIZE

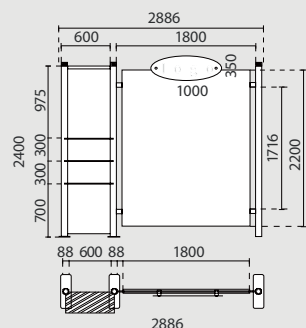

ARTWORK

*mm

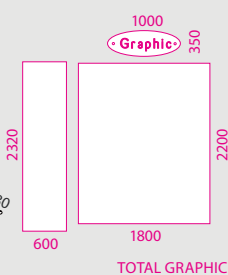

* Printing is available but not included.

CONTENT

EN

Flexible Pop-Up wall system. Easy assembly.
 • Pop-Up 3x1: 3 units.
 • Corner Accessories: 3 units.
 • Plastic trolley Case: 2 units.

FR

Pop-Up magnétique facile à monter.
 • Pop-Up 3x1: 3 unités.
 • Accessoires pour les angles: 3 unités.
 • Valise de transport en plastique: 2 unités.

PT

Pop-Up magnético de fácil montagem.
 • Pop-Up 3x1: 3 unidades.
 • Acessórios das esquinas: 3 unidades.
 • Mala de transporte em plástico: 2 unidades.

ES

Sistema de Pop-Up flexible y de fácil montaje.
 • Pop-Up 3x1: 3 unidades.
 • Accesorios para esquinas: 3 unidades.
 • 2 Maletas de plástico.

PESCARA



2 trolley cases included



3 spaces divided to expose

WALL DETAILS



INFORMATION

Pescara is a flexible 3-walls booth graphics system made up of a Pop-up structure to create an impressive triple spaced trade show booth. With a top height of 2340mm, this event fixture features enough space for setting up counters, chairs or any display and create 3 conference environments for your business. Ideal for meeting one-on-one with potential customers at a trade show. Composed by a straight frame for 3 graphic sides and 3 corner accessories. The portable display breaks down quickly, fitting neatly into the 2 portable carrying bags (included) to transport back to your business or to the next event. The 2 trolley cases are made of heavy-duty molded plastic and features roller wheels, dual handles, and locking security.

EXTERNAL SIZE & ARTWORK

*mm

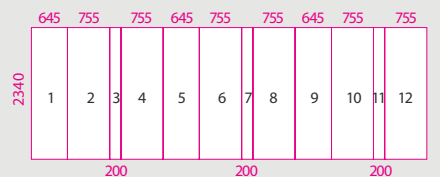
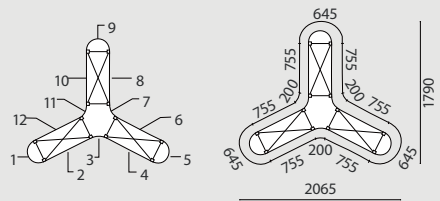

TOTAL GRAPHIC

PESCARA	QTY	N.W	G.W	C.B.M	SIZE
Packing	1	68.5kg	70kg	0.31	730x430x1010mm
				0.31	730x430x1010mm
10.639					

* Printing is available but not included.

FLORENCIA

CONTENT

EN

Flexible Pop-Up wall system. Easy assemble.
 • Pop-Up 3x3: 1 unit / Pop-Up 3x2: 2 units.
 • Accessories corners: 3 units.
 • Spotlights: 2 units. • Trolley Cases: 2 units.

FR

Pop-Up magnétique facile à monter.
 • Pop-Up 3x3: 1 unité. / Pop-Up 3x2: 2 unités.
 • Foyer d'éclairage: 2 unités.
 • Accessoires pour les angles: 3 unités.
 • Valise de transport : 2 unités.

PT

Pop-Up magnético de fácil montagem.
 • Pop-Up 3x3: 1 unid. / Pop-Up 3x2: 2 unid.
 • Focos: 2 unid. • Acessórios das esquinas: 3 unidades.
 • Mala de transporte: 2 unidades.

ES

Sistema de Pop-Up flexible y de fácil montaje.
 • Pop-Up de 3x3: 1 unidad / Pop-Up 3x2: 2 unidades.
 • 2 focos. • Accesorios para esquinas: 3 unidades.
 • 2 Maletas tipo Trolley.

2 spotlights are included

2 trolley cases included



WALL DETAILS



INFORMATION

Florencia is a flexible 3-walls booth graphics system made up of a Pop-up structure to create an impressive triple spaced trade show booth. With a top height of 2340mm, this event fixture features enough space for setting up counters, chairs or any display and create 2 conference environments for your business. Ideal for meeting one-on-one with potential customers at a trade show. Composed by a straight 3x3 frame, two 3x2 straight frames, 3 corner accessories and 2 spotlights. The portable display breaks down quickly, fitting neatly into the 2 portable carrying bags (included) to transport back to your business or to the next event. The 2 trolley cases are made of heavy-duty molded plastic and features roller wheels, dual handles, and locking security.

EXTERNAL SIZE & ARTWORK

*mm

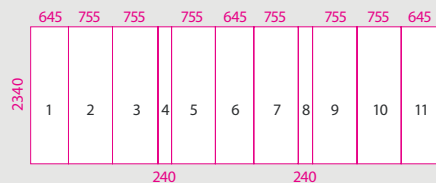
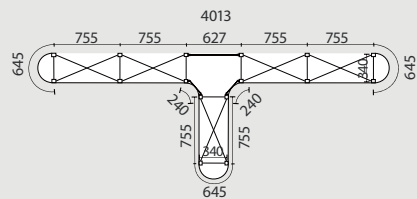

TOTAL GRAPHIC

FLORENCIA	QTY	N.W	G.W	C.B.M	SIZE
Packing	1	83kg	85.5kg	0.31	730x430x1010mm
				0.31	730x430x1010mm
10.644					

* Printing is available but not included.

FLOOR SYSTEM DETAILS



EXTERNAL SIZE

*mm

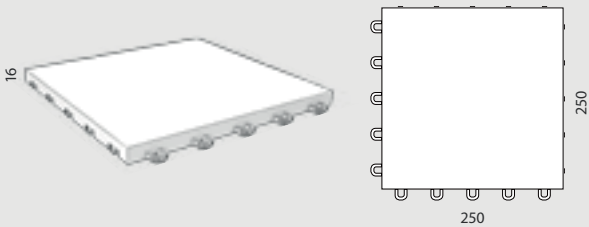

INFORMATION

Snap together these plastic interlocking floor tiles for an easy install and quick setup. Flooring made of high impact material results in long term use and dependability. Beneath each of the floor tiles there are ribbed support pillars for impact and shock absorption. Whether the 250x250mm configuration is used in a trade show booth exhibit, these multi-purpose floor tiles are suitable for indoor or outdoor events. Each unit with the reinforced composition provides a strong foundation efficient for impact and shock absorption. Ideal for a trade show booth set up. 5 colors available.

15.209



x16  (1m²)

TILE FOR FLOOR SYSTEM



FLOOR SYTEM DETAILS

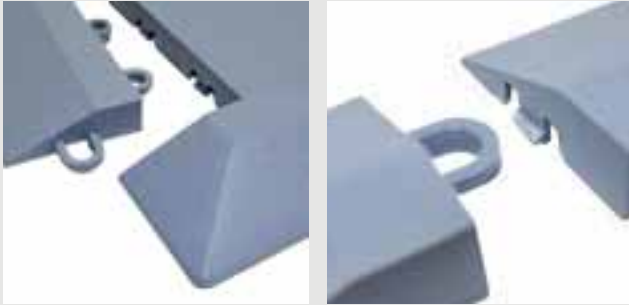

FLOOR SYTEM DETAILS







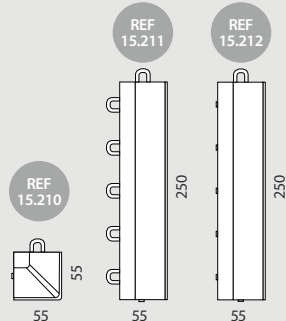

EXTERNAL SIZES

*mm

Flooring construction is made easy with the clip and loop plastic tiles which allow each component to snap together without any tool. Create a finished and clean look by adding the sloped edge and mitered corner attachments to the perimeter for a smooth transition into a trade show booth. Each unit with the reinforced composition provides a strong foundation efficient for impact and shock absorption. Ideal for a trade show booth set up. 5 colors available.



15.210		Corner x4 
15.211		Frame Male x8 
15.212		Frame Female x8 

FRAME FOR FLOOR SYSTEM

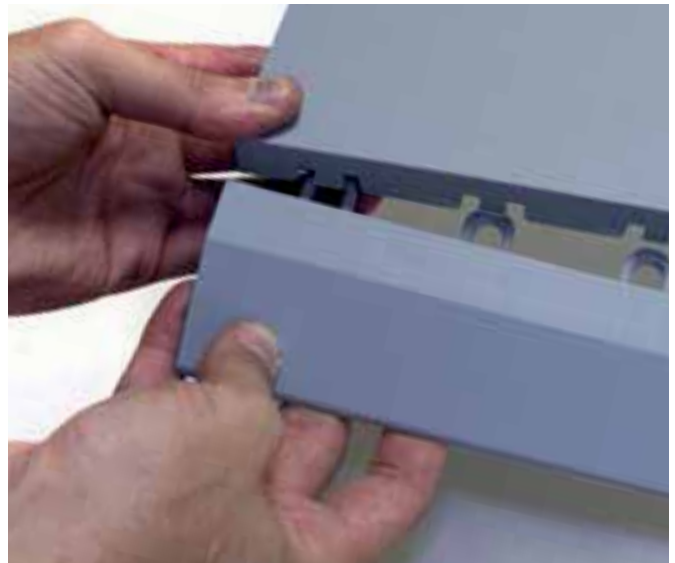

QUICK SYSTEM



TELESCOPIC POLE

aluminium pole system



1200 POLE		1500 POLE		2000 POLE	
*mm		*mm		*mm	
POLE 1		POLE 2		POLE 3	
10.961	Ø45x1200mm	10.962	Ø45x1500mm	10.963	Ø45x2000mm

7 WAYS CONNECTOR



CONNECTOR		*mm
7 WAYS CONNECTOR		
10.968-40	Ø40mm	
10.968-45	Ø45mm	

ALU BLOCK

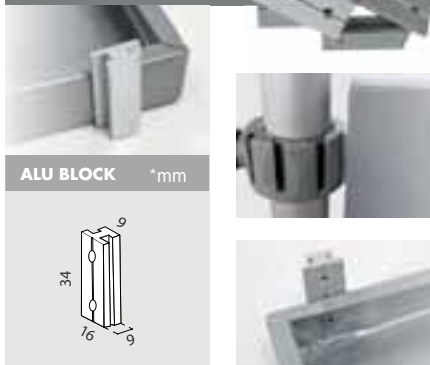

ALU BLOCK		*mm
ALU BLOCK		
10.969	x10 	

RAIL



INFORMATION		*mm
- Combine it with: + pvc insert + end caps + connecting plate + side connecting block + back connecting block		
RAIL		
10.970	Length: 2 meters	

POLES END CAPS



CAP		*mm
END CAPS		
10.966	x10 	

BASE CONNECTOR



BASE CONN.		*mm
BASE CONN.		
10.967		

screw to the base

SQUARE BASE

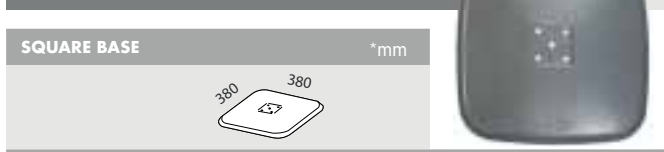

SQUARE BASE		*mm
SQUARE B.		
10.964	380x380	

FEET BASE

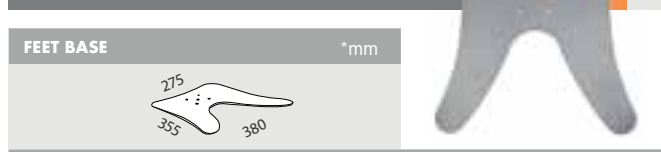

FEET BASE		*mm
FEET BASE		
10.965		

PVC INSERT

INFO *mm

- Stick it to the PVC
Adhesive

12

PVC INSERT

10.862

Length: 2 meter

SIDE CONNECTING BLOCK

BLOCK *mm

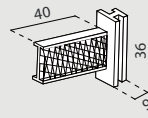

10.863

x10 

BACK CONNECTING BLOCK

INFO *mm

- Rail connection.

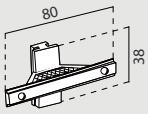

BACK C.B.

10.864

x10 

END CAP

INFO *mm

- Connect it to a rail.
- Grey color finished.

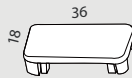

END CAP

10.971

x10 

GRAPHIC CLIP

CLIP *mm



G.CLIP

10.539

Ø45mm

x10 

10.540

Ø40mm

x10 

WIRE CLIP

INFO *mm

- Wires holder.



WIRE CLIP

10.541

Ø45mm

x10 

10.542

Ø40mm

x10 

INFO *mm

- 19mm width.
- Front connection.

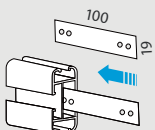

C.PLATE 19

10.972

x10 

100x19mm 

CONNECTING PLATE

INFO *mm

- 12mm width.
- Sideway connection.

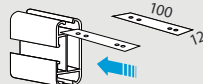

C.PLATE 12

10.973

x10 

100x12mm 

PLASTIC CLIP

INFO

- Plastic.
- Ideal for holding poster or banner.



PLASTIC CLIP

10.537

x10 

SIDE CLIP

INFO

- Plastic.



SIDE CLIP

10.538

x10 

ARC SHELF

INFO

- Includes 2 Alu Block.



+2 Alu block included



10.959

828x350mm

SHELF

INFO

- Includes 4 Alu Block.



+4 Alu block included



10.960

825x400mm

LCD BRACKET

INFO

- Plastic.
- Includes 1 Alu Block.



+1 Alu block included



10.543



PANEL

INFO

- Metallic.
- Perforated.
- Includes 4 Alu Block.



+4 Alu block included



10.958

825x1000mm

all brochures holders include Alu Block



INFO

- Includes 1 Alu Block.
- For A4 size documents.

BROCH. A4

10.544

A4



INFO

- Includes 1 Alu Block.
- For A5 size documents.

BROCH. A5

10.545

A5

ACRILYC BROCHURE HOLDER



INFO

- Includes 1 Alu Block.
- For A6 size documents.

BROCH. A6

10.546

A6



INFO

- With connecting base. Ideal for illuminating your exhibit booth and shed light on your products.



SPOTLIGHT

10.389

475x138mm

SPOTLIGHT



PROFILE STAND 100mm

INFORMATION

Aluminum profile for the assembly of exhibition stands. Profile dimensions: 100x100mm.

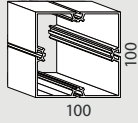

*mm

15.116 100mm

PROFILE STAND 40mm

INFORMATION

Aluminum profile for the assembly of exhibition stands. Profile dimensions: 40x40mm.



*mm

15.118 40mm

ALUMINIUM CONNECTOR FOR PROFILE 100mm

INFORMATION

- 1. Place the connector.
- 2. Adjust the connector into the aluminium profile.

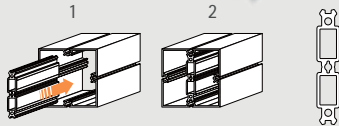

*mm

15.117 Connector 100mm

LOCK

INFORMATION

Use 1 lock for 40mm profile and 2 locks for 100mm profile.

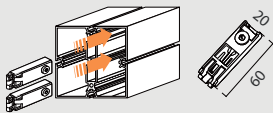

*mm

LOCK 2 Lock for 100mm 1 lock for 40mm

15.119 x2 

PLASTIC PIECES FOR TENSION GRAPHICS

INFORMATION

Use these tension plastic fasteners with springs for attaching your canvas to the profile stand system.

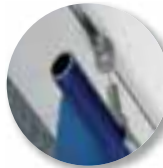
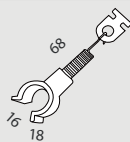

*mm

15.723 x 10 

PROFILE STAND



INFORMATION

- EN Holding system for glass or acrylic performing stand. Suitable for being used with 100mm aluminium profile. Material: Steel.
- FR Système de fixation modulable pour vitres ou acryliques permettant le montage de stands. S'utilise avec un profil stand de 100mm.
- PT Sistema de fixação de vidros ou acrílicos para a montagem de stands. Utiliza-se com um perfil de 100mm. Material: Aço.
- ES Sistema de fijación de cristales o acrílicos para la realización de stand. Se utiliza con el profile stand de 100mm. Material: Acero.

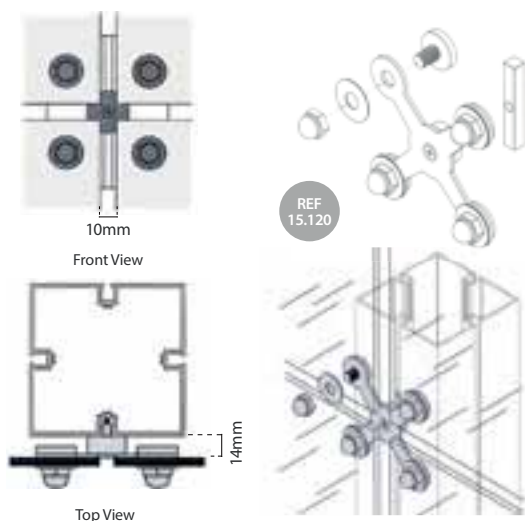

GLASS WALL



INFORMATION

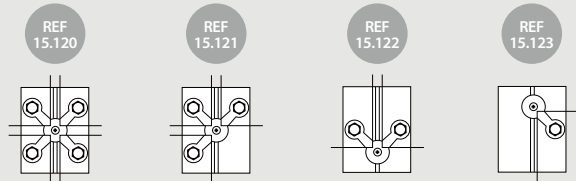

HOLES TEMPLATE

*mm

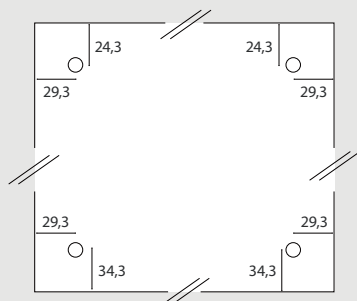

Dimensions for holes on glass or acrylic. / Dimensions pour le cristal ou l'acrylique. Medidas para furos em vidro ou acrílico. / Medidas para agujeros en cristal o acrílico.

GLASS WALL	PARTS
15.120	4 Parts
15.121	3 Parts
15.122	2 Parts
15.123	1 Part

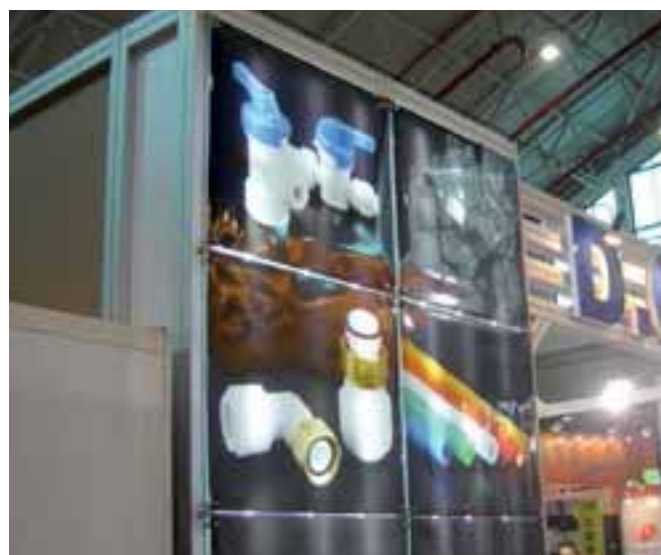

TRUSS DETAILS



light weight
and high
strength



ALUMINIUM
TRUSS "DUO"



STANDARD SIZES

*mm

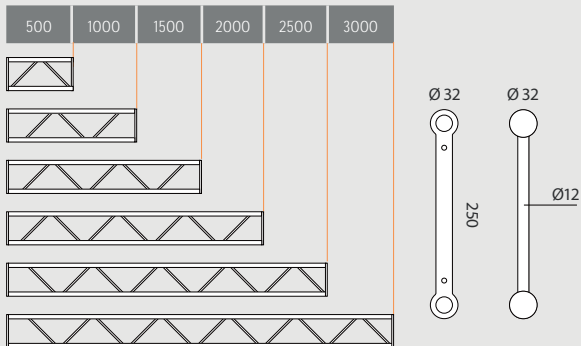

INFORMATION

Aluminium Truss "Duo" formed by 2 aluminum bars, color "natural silver."





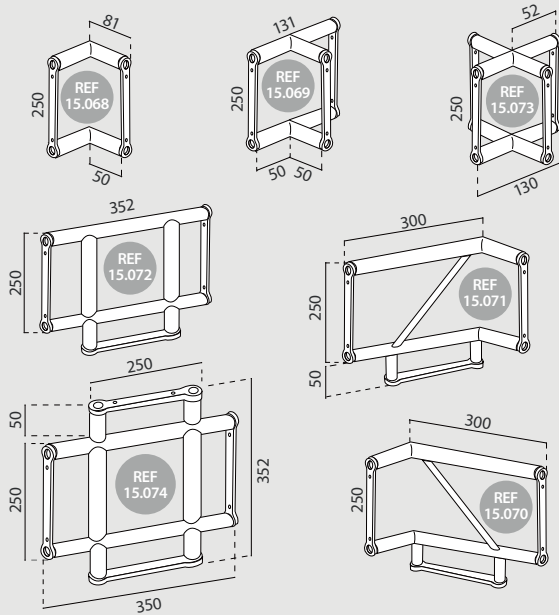

TRUSS DUO	SIZE
15.305	500mm
15.060	1000mm
15.063	1500mm
15.066	2000mm
15.306	2500mm
15.307	3000mm

STANDARD SIZES

*mm



STANDARD SIZES

CONNECTOR	SIZE	
15.068	2 connection sides	
15.069	3 connection sides	
15.070	3 connection sides	
15.071	3 connection sides	
15.072	3 connection sides	
15.073	4 connection sides	
15.074	4 connection sides	

ALUMINIUM TRUSS "DUO" CONNECTOR

TRUSS DETAILS



light weight
and highly
resistant



INSTALL EXPLANATION

*mm

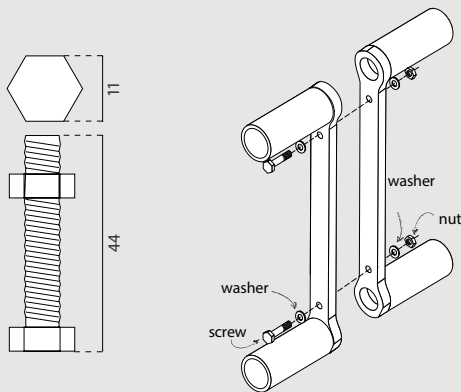

INFORMATION

These screws for mounting the aluminum Truss are made of steel. Nut is supplied.

S CREWS T.	SIZE
15.040	44x11mm

STEEL SCREWS FOR ALUMINIUM TRUSS





INFORMATION

EN	Vertical aluminium Truss, 32 mm diameter. Ideal for producing and assembling a booth, venues, outdoor events, placing graphics, etc. It is characterized by its great resistance, lightweight and easy assembly. Color: natural silver.
FR	Colonne de Truss fabriquée en aluminium, couleur "argent naturel" avec tubes de 32mm de diamètre. Idéal pour la réalisation et le montage de stands, scènes, événements extérieurs, suspension de bâches, etc. Léger, résistant et facile à monter.
PT	Colunas Truss fabricadas em alumínio, em cor prateada, com tubos de 32mm de diâmetro. Ideal para a realização e montagem de stands, cenários, eventos ao ar livre, colocação de lonas, entre outros. Caracteriza-se pela sua grande resistência, leveza e fácil montagem.
ES	Largueros Truss, fabricados en aluminio, color "plata natural", con tubos de 32mm de diámetro. Ideal para realización y montaje de stands, escenarios, eventos al aire libre, colocación de lonas, etc. De gran resistencia, peso ligero y fácil montaje.

ALUMINIUM TRUSS "SHOW"

light weight and resistant

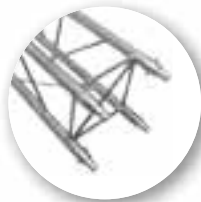
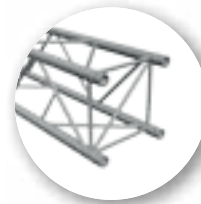

with accessories

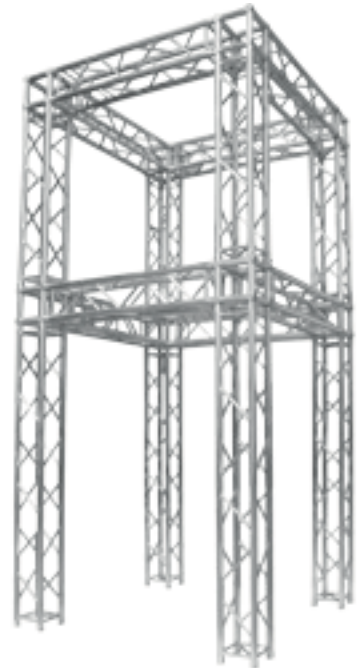

"SHOW"		SIZE	500	750	1000	1500	2000	2500	3000
15.301		500x250mm							
15.302		750x250mm							
15.141		1000x250mm							
15.143		1500x250mm							
15.145		2000x250mm							
15.303		2500x250mm							
15.304		3000x250mm							

MAIN TUBES	Ø32x1.2mm
BRACES	Ø12x1.0mm
MATERIAL	Alloy En-Aw 6005 T6
WEIGHT	1.84 kg/m

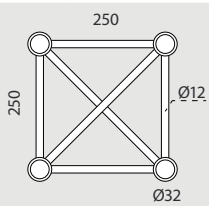

INFORMATION

EN	Connectors for joining Truss spars. Produced in aluminum and with "natural silver" finish.
FR	Cube pour l'union de colonnes de Truss. Fabriqué en aluminium est de couleur "argent naturel".
PT	Cubos de união para colunas Truss fabricados em alumínio de cor prateada.
ES	Cubos para unión de largueros de Truss. Fabricados en aluminio con acabado "plata natural".



CONNECTOR T.	SIZE
15.147	250x250x250mm

CONNECTOR TRUSS



CONICAL CONNECTOR



INFO

Conical connector for joining Truss bars.

15.148	
--------	--

HALF CONICAL CONNECTOR



INFO

Conical semiconnector for joining Truss bars + bolt.

15.151	
--------	--

PIN



INFO

Pin for the connection of Truss bars

15.149	
--------	--

INFORMATION

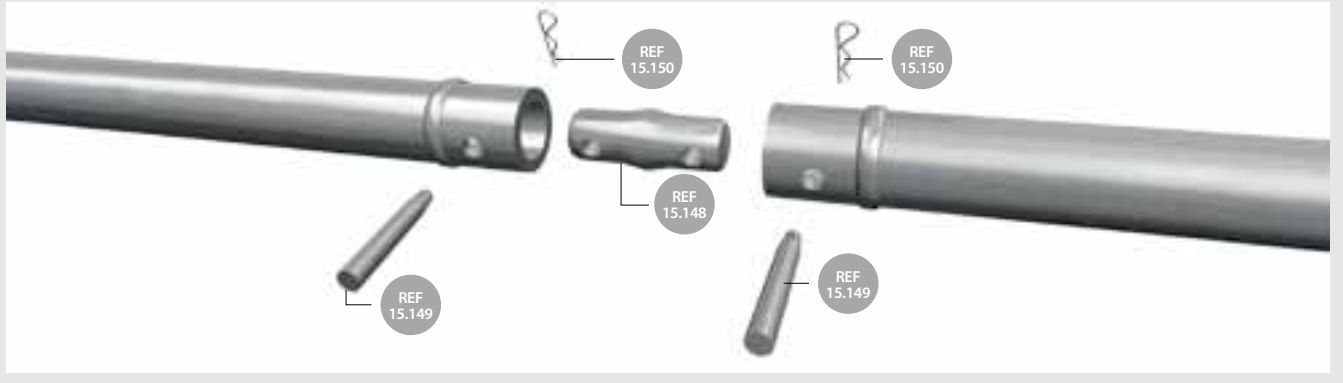

SAFETY CLIP



INFO

Clip to secure the connection of Truss bars

15.150	
--------	--

BASE FOR ALUMINIUM TRUSS "SHOW"

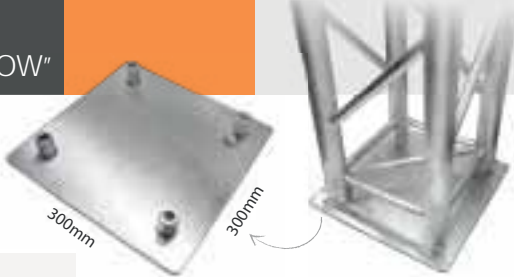

INFO

Steel base for aluminium Truss "Show".

15.300	300x300mm
--------	-----------

INSTALL EXPLANATION

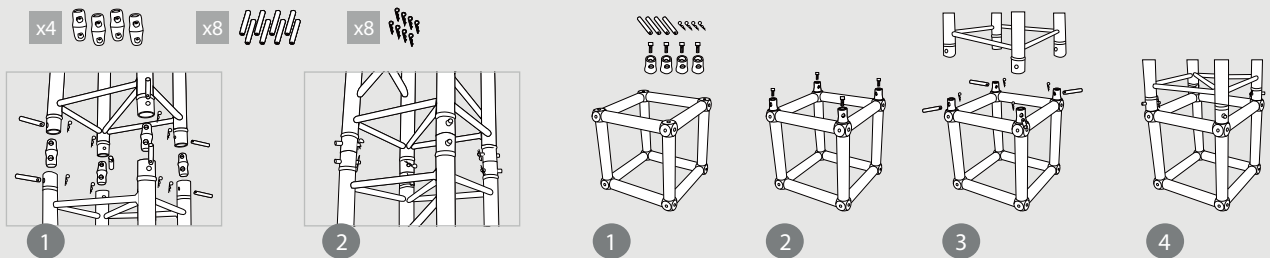

CAMIN



STOOL DETAILS



INFORMATION

The Camin Bar Stool features an adjustable 850mm max height and it is made of Polypropylene plastic with chromed finished structure. 2 colors available.

CAMIN	QTY	N.W	G.W	C.B.M	SIZE
Packing	1	10.7kg	11.07kg	0.052	460x300x420mm
31.284	<input type="checkbox"/>	380x850x380mm			640-850mm
	<input type="checkbox"/>				

MONET



STOOL DETAILS



INFORMATION

The Monet Bar Stool features a pressure lever for an optimal height adjustment. With seat made of ABS plastic and chromed finished structure.

MONET	QTY	N.W	G.W	C.B.M	SIZE
Packing	2	13.8kg	14.6kg	0.088	420x410x515mm
31.033	<input checked="" type="checkbox"/>	350x940x420mm			730-940mm

STOOL DETAILS



INFORMATION

The Tiepolo Bar Stool features a pressure lever for getting an optimal height adjustment. With seat made of ABS plastic and chromed finished structure.

TIEPOLO	QTY	N.W	G.W	C.B.M	SIZE
Packing	2	13.5kg	14.3kg	0.170	570x490x610mm
31.043	<input type="checkbox"/>	470x960x470mm			750-960mm
31.044	<input checked="" type="checkbox"/>				
31.045	<input checked="" type="checkbox"/>				

TIEPOLO



CHAIR DETAILS



MISTRAL



CHAIR DETAILS



INFORMATION

The Mistral Chair features a 800mm height with a seat made of Polypropylene plastic with a chromed finished four-legged structure. 2 colors available.

MISTRAL	QTY	N.W	G.W	C.B.M	SIZE
Packing	1	16.6kg	18.2kg	0.123	570x570x540mm
31.281	<input type="checkbox"/>	575x800x525mm			800mm
	<input type="checkbox"/>				

BORGES



CHAIR DETAILS



INFORMATION

The Borges Chair features a 765mm height with a back and seat made of Polypropylene. And it has a four-legged beech frame. 2 colors available.

BORGES	QTY	N.W	G.W	C.B.M	SIZE
Packing	1	4.1kg	5.2kg	0.1238	780x560x170mm
31.280	<input type="checkbox"/>	420x765x480mm			765mm
	<input type="checkbox"/>				

MARTI



STOOL DETAILS



INFORMATION

The Marti Stool features a 865mm height with a seat made of Polypropylene plastic with a chromed finished four-legged structure. 2 colors available.

MARTI	QTY	N.W	G.W	C.B.M	SIZE
Packing	1	22.5kg	23.6kg	0.23	570x460x850mm
31.283	<input type="checkbox"/>	410x865x400mm			865mm
	<input type="checkbox"/>				

DELMAR



STOOL DETAILS



INFORMATION

The Delmar Stool features a 865mm height with a seat made of Polypropylene plastic. And it has a four-legged wooden structure. 2 colors available.

DELMAR	QTY	N.W	G.W	C.B.M	SIZE
Packing	1	4.6kg	5.9kg	0.064	780x450x200mm
31.282	<input type="checkbox"/>	390x865x440mm			865mm
	<input type="checkbox"/>				

TABLE DETAILS



INFORMATION

The Rubens Bar Table features a Ø600mm top surface made of ABS plastic with a stable chromed finished structure. With 2 colors available.

RUBENS	QTY	N.W	G.W	C.B.M	SIZE
Packing	1	7.3kg	8.1kg	0.108	620x200x620mm 180x180x990mm
31.037	<input type="checkbox"/>	Ø600x1090mm		 1090mm	
31.038	<input type="checkbox"/>				

RUBENS



TABLE DETAILS



TABLE DETAILS



INFORMATION

The Frost Bar Table features a Ø600mm top surface made of ABS plastic with a stable chromed finished structure. With 2 colors available.

FROST	QTY	N.W	G.W	C.B.M	SIZE
Packing	1	6.5kg	7.8kg	0.077	620x200x620mm
31.286	<input type="checkbox"/>	Ø600x735mm		 735mm	
	<input type="checkbox"/>				

FROST



TABLE DETAILS

