

new

FRAME DETAILS



INFORMATION

* W: Width H: Height D: Depth *mm

click

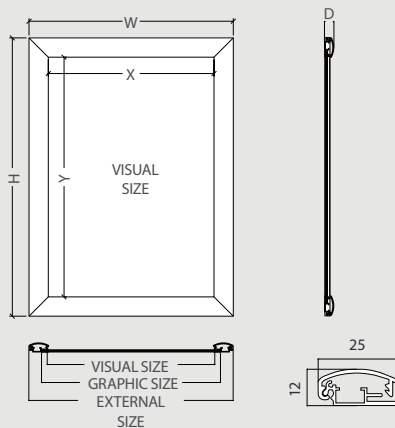
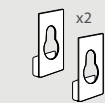



The Maracay frame is economically priced because the profile is thinner and lightweight than other frames. Once this display is wall mounted though there is virtually no difference. Perfect for restaurants, retail stores, community centers, theatres, airports, supermarkets. Anti-reflective cover and screws included.

MARACAY





MARACAY A4 W: Width H: Height D: Depth *mm

	QTY	N.W	G.W	C.B.M	Size (WxHxD)
Packing	10	0.4kg	5.1kg	0.0205	355x210x275
		Visual (X-Y)	External (WxHxD)		
Product		196x282	246x332x13		

14.124   Graphic Size: A4



MARACAY A3 W: Width H: Height D: Depth *mm

	QTY	N.W	G.W	C.B.M	Size (WxHxD)
Packing	10	0.57kg	8.2kg	0.0363	480x210x360
		Visual (X-Y)	External (WxHxD)		
Product		284x409	334x507x13		

14.123   Graphic Size: A3



MARACAY A2 W: Width H: Height D: Depth *mm

	QTY	N.W	G.W	C.B.M	Size (WxHxD)
Packing	10	0.91kg	13.2kg	0.0672	660x210x485
		Visual (X-Y)	External (WxHxD)		
Product		406x587	456x637x13		

14.122   Graphic Size: A2



MARACAY A1 W: Width H: Height D: Depth *mm

	QTY	N.W	G.W	C.B.M	Size (WxHxD)
Packing	5	1.5kg	11.7kg	0.0726	910x120x665
		Visual (X-Y)	External (WxHxD)		
Product		587x838	637x888x13		

14.121   Graphic Size: A1



MARACAY H700 W: Width H: Height D: Depth *mm

	QTY	N.W	G.W	C.B.M	Size (WxHxD)
Packing	10	1.22kg	14.7kg	0.0910	760x210x570
		Visual (X-Y)	External (WxHxD)		
Product		488x694	538x744x13		

14.126   Graphic: 500x700mm

MARACAY H1000 W: Width H: Height D: Depth *mm

	QTY	N.W	G.W	C.B.M	Size (WxHxD)
Packing	5	1.7kg	12.9kg	0.0979	1060x120x770
		Visual (X-Y)	External (WxHxD)		
Product		693x986	743x1036x13		

14.125   Graphic: 700x1000mm

FRAME DETAILS



ANADIA



INFORMATION

* W: Width H: Height D: Depth *mm

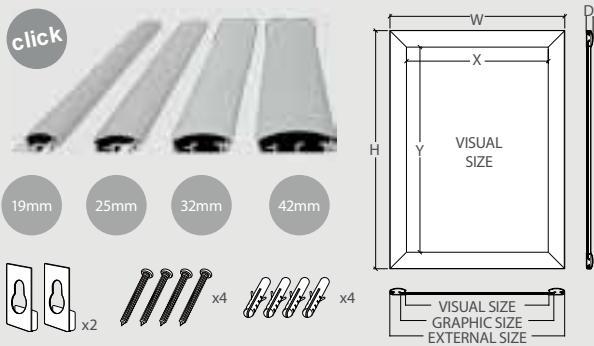

The Anadia frame is constructed from anodized aluminum with a matte silver finish. It features Click spring-loaded action, so updating a presentation takes only a few seconds. It includes screws and hangers for wall mounting. This frame is perfect for restaurants, retail stores, movie theatres, airports, malls, banks or for any other location requiring a frequent change of the graphics.



ANADIA

* W: Width H: Height D: Depth *mm

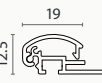
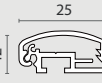
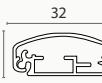
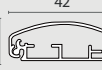
Ref.	Graphic Size	Visual (X-Y)	External (WxHxD)	Profile	Packing (QTY)	N.W	G.W	C.B.M	Size (WxHxD)
10.314	A4	199x286	237x324x12.50		1	0.4kg	0.5kg	0.024	270x350x25
10.315	A3	286x409	324x477x12.50		1	0.7kg	0.85kg	0.0061	365x480x35
10.316	A2	409x583	447x621x12.50		1	1kg	1.3kg	0.0067	475x645x22
10.317	500x700	489x689	527x727x12.50		1	1.3kg	1.7kg	0.0104	560x745x25
10.214	A4	190x278	242x329x12		1	0.45kg	0.55kg	0.0024	270x350x25
10.213	A3	278x401	329x452x12		1	0.65kg	0.85kg	0.0061	365x480x35
10.212	A2	401x575	452x626x12		1	1.05kg	1.35kg	0.0067	475x645x22
10.215	500x700	480x680	532x732x12		1	1.4kg	1.8kg	0.0104	560x745x25
10.290	A3	275x398	339x462x13.3		1	0.8kg	1.05kg	0.0061	365x480x35
10.291	A2	398x572	462x636x13.3		1	1.2kg	1.6kg	0.0067	475x645x22
10.292	A1	572x819	663x884x13.3		1	2kg	2.45kg	0.0143	645x886x25
10.293	500x700	478x678	542x742x13.3		1	1.5kg	2kg	0.0104	560x745x25
10.294	700x1000	678x978	742x1042x13.3	1	2.55kg	3.25kg	0.0197	1075x780x25	
10.296	A0	821x1169	905x1253x14.5		1	4kg	5.04kg	0.0291	1265x920x25
10.295	700x1000	680x980	764x1064x14.5		1	3kg	3.75kg	0.0197	1075x780x25
10.297	1000x1400	980x1380	1064x1464x14.5		1	5.55kg	6.7kg	0.0398	1475x1080x25

FRAME DETAILS



ANADIA
DOUBLE-SIDED



INFORMATION

* W: Width H: Height D: Depth

click



42mm

32mm

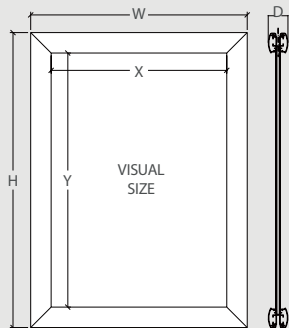



The Double-sided Anadia frame is constructed from aluminum and has a matte silver finish. It can be mounted vertically or horizontally, depending on your sign or advertisement. We supply this frame with the necessary screws and hangers for hanging. Insert your posters or graphics on top of the back panel, replace the lens and flip the sides down. This frame features 2 ways visibility, increasing advertisement exposure. Ideal for hanging in a storefront window or from the ceiling allow for placement overhead, in a central location.

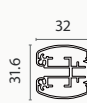

ANADIA DOUBLE-SIDED

* W: Width H: Height D: Depth *mm

Ref.	Graphic Size	Visual (X-Y)	External (WxHxD)	Profile	Packing (QTY)	N.W	G.W	C.B.M	Size (WxHxD)
10.299	A3	283x406	347x470x31.6		1	1.25kg	1.6kg	0.0061	480x365x35
10.300	A2	406x580	470x664x31.6		1	1.85kg	2.15kg	0.0127	485x655x40
10.302	A1	580x827	644x891x31.6		1	2.8kg	3.25kg	0.0235	660x890x40
10.303	500x700	486x686	550x750x31.6		1	2.3kg	2.8kg	0.0172	565x760x40
10.562	A0	807x1155	891x1239x33.9		1	4.7kg	6.2kg	0.0430	905x1250x38
10.566	700x1000	666x966	750x1050x33.9		1	4kg	4.85kg	0.0323	765x1055x40

FRAME DETAILS



LIMA



INFORMATION

* W: Width H: Height D: Depth

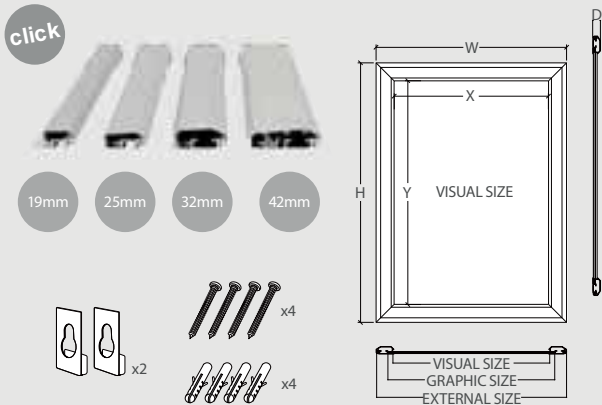





The Lima frame is constructed from anodized aluminum with a matte silver finish. It features Click spring-loaded action, so updating a presentation takes only a few seconds. It can be mounted vertically or horizontally and it includes screws and hangers for wall mounting. This frame is perfect for restaurants, retail stores, movie theatres, airports, malls, banks or for any other location requiring a frequent change of the graphics.



LIMA

* W: Width H: Height D: Depth *mm

Ref.	Graphic Size	Visual (X-Y)	External (WxHxD)	Profile	Packing (QTY)	N.W	G.W	C.B.M	Size (WxHxD)
10.210	A4	199x286	237x324x11.95	 11.95	1	0.4kg	0.5kg	0.0024	270x350x25
10.209	A3	286x409	324x477x11.95		1	0.7kg	0.85kg	0.0061	365x480x35
10.208	A2	409x583	447x621x11.95		1	1kg	1.3kg	0.0067	475x645x22
10.211	500x700	489x689	527x727x11.95		1	1.3kg	1.7kg	0.0104	560x745x25
10.260	A4	190x278	242x329x11.5	 11.5	1	0.45kg	0.55kg	0.0024	270x350x25
10.259	A3	278x401	329x452x11.5		1	0.65kg	0.85kg	0.0061	365x480x35
10.258	A2	401x575	452x626x11.5		1	1.05kg	1.35kg	0.0067	475x645x22
10.261	500x700	480x680	532x732x11.5		1	1.4kg	1.8kg	0.0104	560x745x25
10.262	A3	275x398	339x462x13.75	 13.75	1	0.8kg	1.05kg	0.0061	365x480x35
10.263	A2	398x572	462x636x13.75		1	1.2kg	1.6kg	0.0067	475x645x22
10.264	A1	572x819	663x884x13.75		1	2kg	2.45kg	0.0143	645x886x25
10.266	500x700	478x678	542x742x13.75		1	1.5kg	2kg	0.0104	560x745x25
10.267	700x1000	678x978	742x1042x13.75	1	2.6kg	3.5kg	0.0197	1075x780x25	
10.270	A0	821x1169	905x1253x13.75	 13.75	1	4kg	5.04kg	0.0291	1265x920x25
10.272	700x1000	680x980	764x1064x13.75		1	3kg	3.75kg	0.0197	1075x780x25
10.268	1000x1400	980x1380	1064x1464x13.75		1	5.5kg	6.7kg	0.0398	1475x1080x25

FRAME DETAILS



LIMA
DOUBLE-SIDED



INFORMATION

* W: Width H: Height D: Depth

click



32mm

42mm

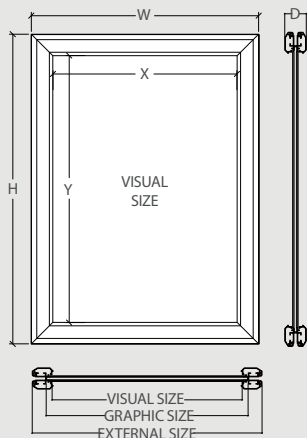
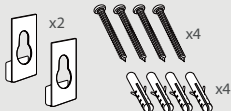



The Double-sided Lima frame is constructed from aluminum and has a matte silver finish. It can be mounted vertically or horizontally, depending on your sign or advertisement. We supply this frame with the necessary screws and hangers for hanging. Insert your posters or graphics on top of the back panel, replace the lens and flip the sides down. This frame features 2 ways visibility, increasing advertisement exposure. Ideal for hanging in a storefront window or from the ceiling allow for placement overhead, in a central location.



LIMA DOUBLE-SIDED

* W: Width H: Height D: Depth *mm

Ref.	Graphic Size	Visual (X-Y)	External (WxHxD)	Profile	Packing (QTY)	N.W	G.W	C.B.M	Size (WxHxD)
10.563	A3	283x406	347x470x32.39		1	1.25kg	1.6kg	0.0061	480x365x35
10.564	A2	406x580	470x664x32.39		1	1.85kg	2.15kg	0.0127	485x655x40
10.565	A1	580x827	644x891x32.39		1	2.8kg	3.25kg	0.0235	660x890x40
10.289	500x700	486x686	550x750x32.39		1	2.3kg	2.8kg	0.0172	565x760x40
10.257	A0	807x1155	891x1239x32.39		1	4.7kg	6.2kg	0.0430	905x1250x38
10.560	700x1000	666x966	750x1050x32.39		1	4kg	4.85kg	0.0323	765x1055x40

FRAME DETAILS



INFORMATION

* W: Width H: Height D: Depth

click



42mm

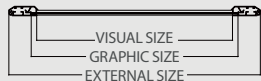
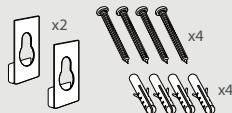
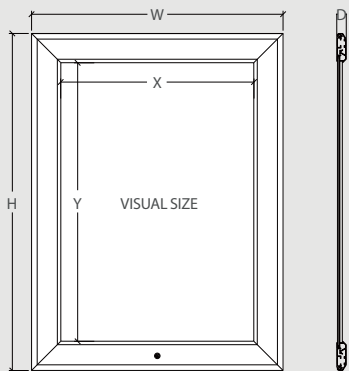

The Lima frame is constructed from anodized aluminum with a matte silver finish and it features a front-loading frame which can be secured shut with an Allen key to keep posters protected. It can be mounted vertically or horizontally. Screws and allen key wrench included. This frame is perfect for being used in restaurants, retail stores, community centers, movie theatres, airports, banks or any other location requiring frequent changes of advertisements.

LIMA
LOCKABLE



LIMA LOCKABLE

* W: Width H: Height D: Depth *mm

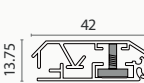
Ref.	Graphic Size	Visual (X-Y)	External (WxHxD)	Profile	Packing (QTY)	N.W	G.W	C.B.M	Size (WxHxD)
10.280	A1	574x821	658x905x13.75		1	2.3kg	3.1kg	0.0153	672x912x25
10.281	A0	821x1169	905x1253x13.75		1	4kg	5.04kg	0.0291	1265x920x65
10.282	500x700	480x680	564x764x13.75		1	1.8kg	2.35kg	0.0112	580x771x25
10.283	700x1000	680x980	764x1064x13.75		1	3kg	3.75kg	0.0191	1075x780x25
10.278	1000x1400	980x1380	1064x1464x13.75		1	5.55kg	6.7kg	0.0398	1475x1080x25

FRAME DETAILS



LIMA
WATERPROOF



INFORMATION

* W: Width H: Height D: Depth

click



42mm

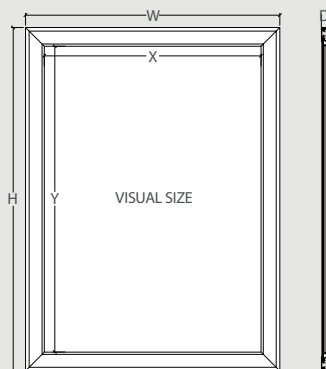
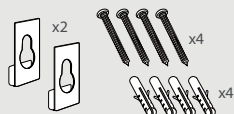

This Lima frame is constructed from anodized durable aluminum with a matte silver finish. It is waterproof, rust proof and it includes an anti-reflective plastic cover, protective overlay to prevent glare. Screws and hangers are included. This frame is perfect for being used in restaurants, retail stores, community centers, movie theatres, airports, banks or any other outdoor location requiring frequent changes of advertisements.



LIMA WATERPROOF

* W: Width H: Height D: Depth *mm

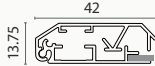
Ref.	Graphic Size	Visual (X-Y)	External (WxHxD)	Profile	Packing (QTY)	N.W	G.W	C.B.M	Size (WxHxD)
10.285	A1	580x827	664x911x13.75		1	2kg	2.5kg	0.0153	672x912x25
10.286	A0	827x1175	911x1259x13.75		1	4kg	5.04kg	0.0291	1265x920x25
10.287	500x700	486x686	570x770x13.75		1	1.65kg	2.01kg	0.0104	560x745x25
10.288	700x1000	686x986	770x1070x13.75		1	3.05kg	3.48kg	0.0191	1075x780x25
10.561	1000x1400	986x1386	1070x1470x13.75		1	5.55kg	6.7kg	0.0398	1475x1080x25

FRAME DETAILS



INFORMATION

* W: Width H: Height D: Depth *mm

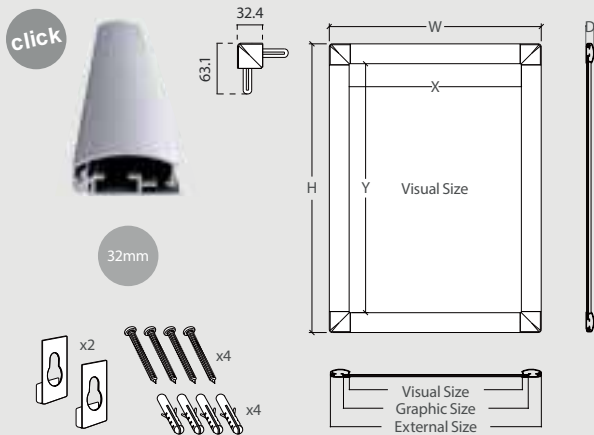

The Serena anodized aluminum frame features a stylish bicolor design. It has a 32mm width profile which features Click closing system. Graphics change takes only a few seconds. Due to its elegant appearance the single-sided frame Serena is ideal for restaurants, hotels, theatres, offices, malls or any other location requiring a distinctive look on the frames or a frequent changes of posters. Also, protective anti-reflection cover, screws and hangers are included.

SERENA



SERENA

* W: Width H: Height D: Depth *mm

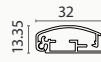
Ref.	Graphic Size	Visual (X-Y)	External (WxHxD)	Profile	Packing (QTY)	N.W	G.W	C.B.M	Size (WxHxD)
10.405	A4	188x275	252x339x13.35		1	0.4kg	0.5kg	0.0024	270x25x350
10.404	A3	275x398	339x462x13.35		1	0.7kg	0.95kg	0.0042	475x22x355
10.403	A2	398x572	462x636x13.35		1	1.05kg	1.45kg	0.0067	475x22x645
10.408	500x700	478x678	542x742x13.35		1	1.35kg	1.85kg	0.0104	560x25x745
10.163	700x1000	678x978	742x1042x13.35		1	2.35kg	3.05kg	0.0197	1075x25x780

FRAME DETAILS

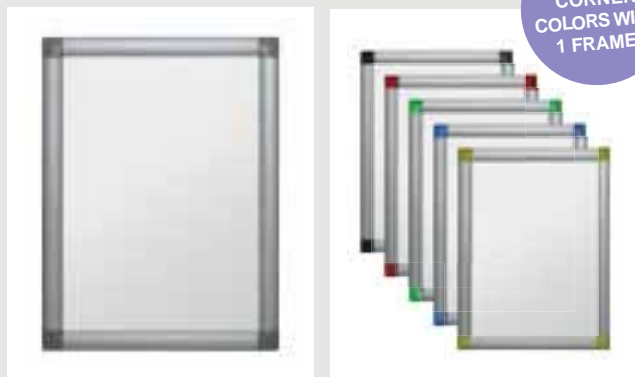

GET 6
CORNER
COLORS WITH
1 FRAME!

RAINBOW
FRAME



INCLUDES 4 GREY CORNERS AND 20 COLORED COVERS



INFORMATION

* W: Width H: Height D: Depth *mm

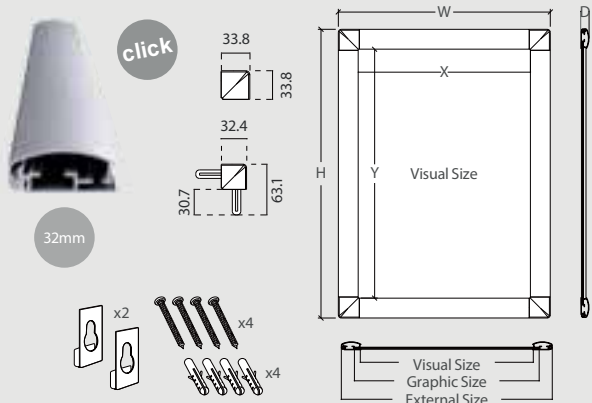

The Rainbow aluminum frame features 4 grey corners + 20 colored covers. It has a 32mm width profile which features click closing system. Insert your graphics on top of the back panel, replace the lens, and flip the sides down to hold everything in place, so updating a presentation takes only a few seconds. It can be mounted vertically or horizontally. Featuring 5 standard sizes available. Due to its versatile design the single-sided frame Rainbow is ideal for restaurants, hotels, theatres, offices, malls or any other location requiring a distinctive look on the frames or a frequent changes of posters. Also, Protective anti-reflection cover, screws and hangers are included.



RAINBOW

* W: Width H: Height D: Depth *mm

Ref.	Graphic Size	Visual (X-Y)	External (WxHxD)	Profile	Packing (QTY)	N.W	G.W	C.B.M	Size (WxHxD)
13.590	A4	188x275	252x339x13.35		1	0.4kg	0.5kg	0.0024	270x25x350
13.591	A3	275x398	339x462x13.35		1	0.7kg	0.95kg	0.0042	475x22x355
13.592	A2	398x572	462x636x13.35		1	1.05kg	1.45kg	0.0067	475x22x645
13.593	500x700	478x678	542x742x13.35		1	1.35kg	1.85kg	0.0104	560x25x745
13.754	700x1000	678x978	742x1042x13.35		1	2.35kg	3.05kg	0.0197	1075x25x780

FRAME DETAILS



DIMENSIONS

* W: Width H: Height D: Depth

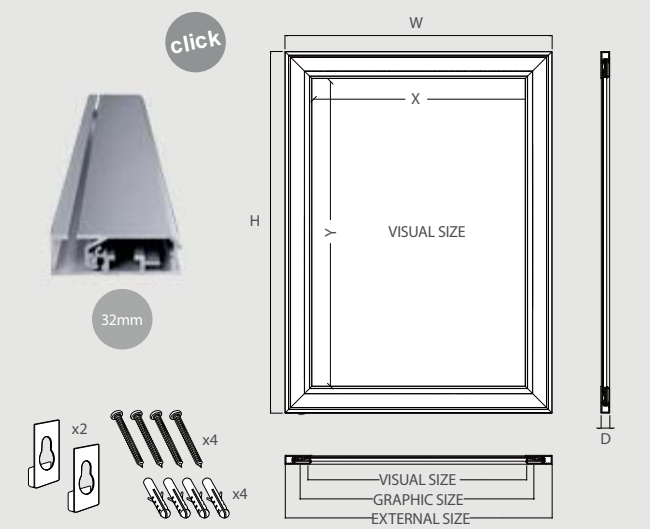

INFORMATION

The Iscar aluminum frame features a stylish design with double-framed appearance. It has a 34.9mm width profile which features click closing system so updating a presentation takes only a few seconds. It can be mounted vertically or horizontally. Featuring 5 standard sizes available. Due to its elegant appearance the double-sided frame Iscar is ideal for restaurants, hotels, theatres, offices, malls or any other location requiring a distinctive look on the frames or a frequent changes of posters. Also, Protective anti-reflection cover, screws and hangers are included.

ISCAR
COVER FRAME



ISCAR		* W: Width H: Height D: Depth *mm								
Ref.	Graphic Size	Visual (X-Y)	External (WxHxD)	Profile	Packing (QTY)	N.W	G.W	C.B.M	Size (WxHxD)	
13.635	A3	278x401	346x471x11.5		1	1.04kg	1.19kg	0.0044	485x365x25	
13.636	A2	401x575	471x645x11.5		1	1.52kg	1.78kg	0.0080	660x485x25	
13.637	A1	575x822	645x892x11.5		1	2.34kg	2.78kg	0.0149	905x660x25	
13.638	500x700mm	461x681	551x751x11.5		1	1.87kg	2.20kg	0.0108	765x565x25	
13.639	700x1000mm	681x981	751x1051x11.5		1	2.95kg	3.54kg	0.0204	1065x765x25	

FRAME DETAILS



ADDITIONAL COLORS UPON REQUEST

The Trujillo aluminum Click frame is available in more colors upon request*.



RAL 5005

RAL 3020

RAL 6029

WOOD COLOR

INFORMATION

* W: Width H: Height D: Depth *mm

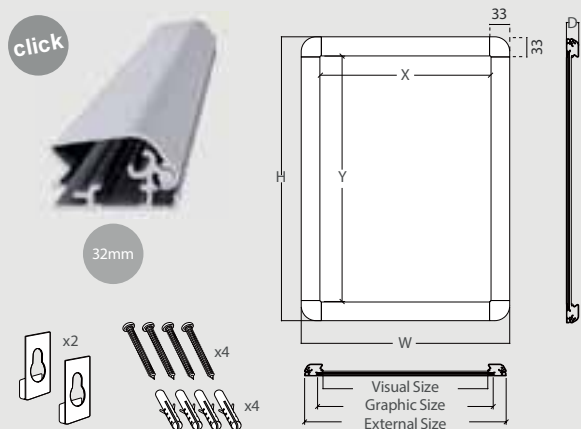

Trujillo aluminum frame features a stylish bicolor design with rounded corners. It can be mounted vertically or horizontally and updating a poster takes only a few seconds. 4 colors available upon request. Ideal for restaurants, markets, malls or any other location requiring frequent changes of posters. Screws and hangers included.

TRUJILLO



TRUJILLO

* W: Width H: Height D: Depth *mm

new

Ref.	Graphic Size	Visual (X-Y)	External (WxHxD)	Profile	Packing (QTY)	N.W	G.W	C.B.M	Size (WxHxD)
10.130	A4	194.2x281	257x344x20.3		1	0.6kg	0.75	0.0039	360x275x40
10.131	A3	278x402	344x468x20.3		1	1kg	1.2kg	0.0061	365x480x35
10.132	A2	402x575	468x641x20.3		1	1.65kg	2.15kg	0.0127	485x655x40
10.133	A1	575x822	641x888x20.3		1	2.4kg	3.2kg	0.0235	660x890x40
10.134	A0	822x1170	888x1236x20.3		1	4.4kg	5.45kg	0.0430	1250x905x38
10.135	500x700	481x681	547x747x20.3		1	1.95kg	2.4kg	0.0104	560x745x25
10.136	700x1000	681x981	747x1047x20.3		1	3.25kg	4kg	0.0323	765x1055x40

FRAME DETAILS



DIMENSIONS

* W: Width H: Height D: Depth

Lublin aluminum frame has an open profile on one of its narrow sides. The change of graphic is really fast and easy, just insert your poster or graphic through the groove on the narrower side (W) of the Lublin frame, so this way, updating a presentation takes only a few seconds.

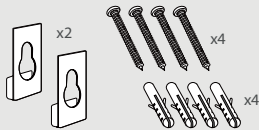
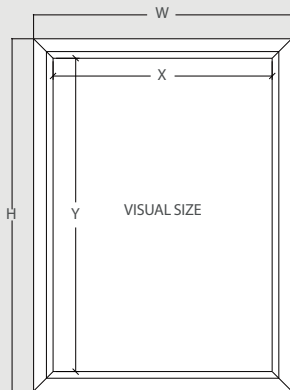

INFORMATION





Lublin frame is made of anodized aluminium. This aluminium is lightweight but durable and can be hung either vertically or horizontally as well. The antireflection plastic cover protects the graphics from tampering. Also, the screws and hangers for wall mounting are included. Lublin frame is ideal for restaurants, supermarkets, banks, movies theatres, airports, malls, offices, lobby, at home or any other location requiring frequent changes of posters.

LUBLIN



LUBLIN

* W: Width H: Height D: Depth *mm

Ref.	Graphic Size	Visual (X-Y)	External (WxHxD)	Profile	Packing (QTY)	N.W	G.W	C.B.M	Size (WxHxD)	
10.594	A4	203x288	233x318x11		1	0.3kg	0.4kg	0.0020	325x245x25	
10.593	A3	290x411	320x441x11		1	0.5kg	0.65kg	0.0037	450x332x25	
10.588	A2	454x626	404x576x15		1	1kg	1.3kg	0.0074	633x466x25	
10.587	A1	628x872	578x822x15		1	1.7kg	2.25kg	0.0135	880x640x24	

FRAME DETAILS



DIMENSIONS

* W: Width H: Height D: Depth

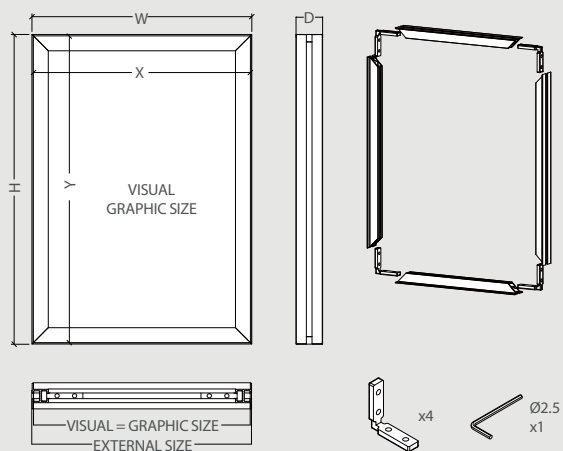

INFORMATION

* W: Width H: Height D: Depth







The Tarnow aluminum frame features a silver or a stunning black finished design for being used with foamboard graphics. It can be mounted vertically or horizontally and updating a poster is simple and fast. 7 standard sizes are available. Corner connections and Allen key are included. The maximum panel or foam thickness is 5mm. The Tarnow frame is ideal for restaurants, hotels, theatres, offices, malls or any other location requiring a distinctive look on the frames or a frequent changes of posters.

TARNOW

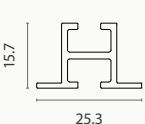

TARNOW

* W: Width H: Height D: Depth *mm

Ref.	Graphic Size	Visual (X-Y)	External (WxHxD)	Profile	Packing (QTY)	N.W	G.W	C.B.M	Size (WxHxD)	
13.628		A4	297x210	213x300x25.3		1	0.34kg	0.42kg	0.0007	360x32x62
13.629		A3	420x297	300x423x25.3		1	0.45kg	0.58kg	0.0010	480x32x62
13.630		A2	594x420	423x597x25.3		1	0.59kg	0.82kg	0.0013	655x32x62
13.631		A1	841x594	597x844x25.3		1	0.80kg	1.21kg	0.0018	905x32x62
13.632		A0	1189x841	844x1192x25.3		1	1.10kg	1.89kg	0.0025	1250x32x62
13.633		500x700	500x700	503x703x25.3		1	0.69kg	1.01kg	0.0015	760x32x62
13.634		700x1000	700x1000	703x1003x25.3		1	0.93kg	1.5kg	0.0021	1060x32x62

FRAME DETAILS



DIMENSIONS

* W: Width H: Height D: Depth * mm

click

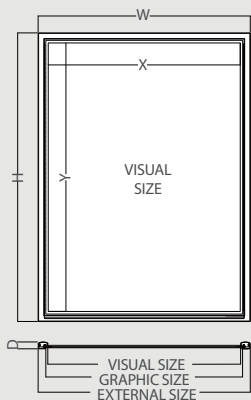
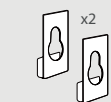

INFORMATION

This hanging light box for daily use combines the power of LED illumination technology with the elegance of a thin profile. The frame on each model is 17.8mm thick, making it one of the slimmest marketing devices currently available. The small LED bulbs in the sides of the window frame prevents against "hot" and "cold" spots appearing on the graphics. Also, the Yucatan Light Box is suitable for wall-mounting.

YUCATAN



YUCATAN					* W: Width	H: Height	D: Depth	*mm	
Ref.	Graphic Size	Visual (X-Y)	External (WxHxD)	Profile	Packing (QTY)	N.W	G.W	C.B.M	Size (WxHxD)
13.207	A0	828x1176	880x1228x17.8		1	7.25kg	10.1kg	0.0737	910x1350x60
13.208	A1	581x828	633x880x17.8		1	3.95kg	5.5kg	0.0398	660x1005x60
13.209	A2	407x581	459x633x17.8		1	2.1kg	3.1kg	0.0222	490x755x60
13.210	A3	284x407	336x459x17.8		1	1.3kg	1.95kg	0.0128	365x585x60
13.211	A4	197x284	249x336x17.8		1	0.8kg	1.2kg	0.0077	280x460x60
13.295	500x700	487x686	539x738x17.8		1	2.85kg	4.1kg	0.0296	570x865x60
13.296	700x1000	687x987	739x1039x17.8	1	5.3kg	7.3kg	0.0538	770x1165x60	

* Other sizes available upon request / Autres dimension sur demande / Outros tamanhos disponíveis sob consulta / Otros tamaños disponibles bajo pedido.

FRAME DETAILS



DIMENSIONS * W: Width H: Height D: Depth * mm

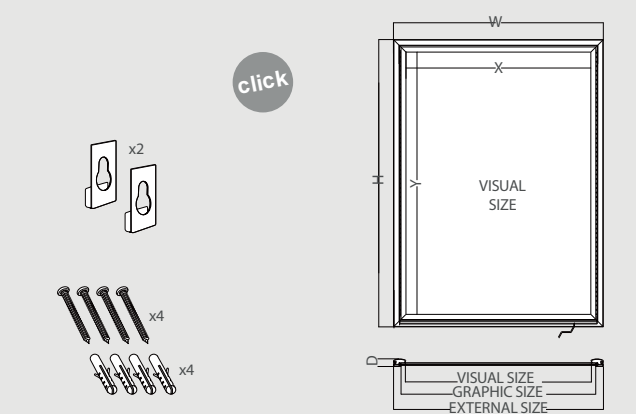

INFORMATION

Artega Light box for daily use combines the power of LED illumination technology with the elegance of a thin anodized aluminium 32mm profile. The frame on each model is 19.75mm thick, making it one of the slimmest marketing devices currently available. The small LED bulbs in the sides of the window prevents against "hot" and "cold" spots appearing on the graphics. Also, the Artega Light Box is suitable for wall-mounting. AC power supply included.

ARTEGA

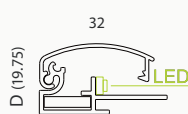

ARTEGA						* W: Width H: Height D: Depth *mm				
Ref.	Graphic Size	Visual (X-Y)	External (WxHxD)	Profile	Packing (QTY)	N.W	G.W	C.B.M	Size (WxHxD)	
13.202	A0	815x1163	880x1228x19.75		1	7.25kg	10.1kg	0.0737	910x1350x60	
13.203	A1	568x815	633x880x19.75		1	3.95kg	5.5kg	0.0398	660x1005x60	
13.204	A2	394x568	459x633x19.75		1	2.1kg	3.1kg	0.0222	490x755x60	
13.205	A3	271x394	336x459x19.75		1	1.3kg	1.95kg	0.0128	365x585x60	
13.206	A4	184x271	249x336x19.75		1	0.8kg	1.2kg	0.0077	280x460x60	
13.293	500x700	474x673	539x738x19.75		1	2.85kg	4.1kg	0.0296	570x865x60	
13.294	700x1000	674x974	739x1039x19.75		1	5.3kg	7.3kg	0.0538	770x1165x60	

* Other sizes available upon request / Autres dimension sur demande / Outros tamanhos disponíveis sob consulta / Otros tamaños disponibles bajo pedido.

FRAME DETAILS



DIMENSIONS

* W: Width H: Height D: Depth

click

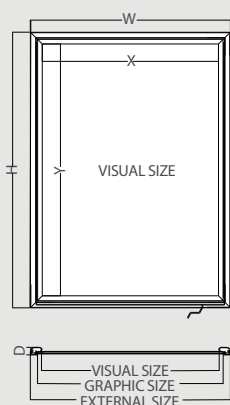
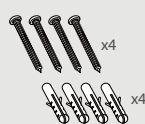
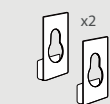

INFORMATION

The Campeche frame display is built from sturdy, durable aluminum frame. With Click System and edge-light LED bulbs, Campeche lightbox stand is useful for darker venues, such as halls and movie theaters. The convex holder helps graphics pop out, ensuring that the double sided poster display can be seen from any angle. Designed for day or night time use, the illuminated lightbox stand has clear PVC lens to prevent glare, while the LED bulbs highlight signage.

CAMPECHE

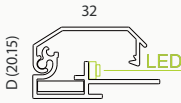

CAMPECHE					* W: Width H: Height D: Depth					*mm
Ref.	Graphic Size	Visual (X-Y)	External (WxHxD)	Profile	Packing (QTY)	N.W	G.W	C.B.M	Size (WxHxD)	
13.217	A0	815x163	880x1228x20.15		1	7.25kg	10.1kg	0.0737	910x1350x60	
13.218	A1	568x815	633x880x20.15		1	3.95kg	5.5kg	0.0398	660x1005x60	
13.219	A2	394x568	459x633x20.15		1	2.1kg	3.1kg	0.0222	490x755x60	
13.220	A3	271x394	336x459x20.15		1	1.3kg	1.95kg	0.0128	365x585x60	
13.221	A4	184x271	249x336x20.15		1	0.8kg	1.2kg	0.0077	280x460x60	
13.291	500x700	474x673	539x738x20.15		1	2.85kg	4.1kg	0.0296	570x865x60	
13.292	700x1000	674x974	739x1039x20.15		1	5.3kg	7.3kg	0.0538	770x1165x60	

* Other sizes available upon request / Autres dimension sur demande / Outros tamanhos disponíveis sob consulta / Otros tamaños disponibles bajo pedido.

FRAME DETAILS



DIMENSIONS

* W: Width H: Height D: Depth

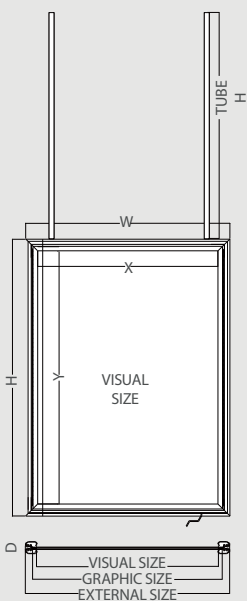

INFORMATION

The Nogales 2-sided frame is built from sturdy, durable aluminum frame. With an easy-to-use snap frame and edge-lit LED bulbs, Lainster lightbox stand is useful for darker venues, such as halls and movie theaters. The vertical holder tubes, ensuring that the double sided poster display can be seen from any angle. Designed for day or night time use, the illuminated lightbox stand has clear PVC lens to prevent glare, while the LED bulbs highlight signage.

NOGALES



NOGALES

* W: Width H: Height D: Depth

*mm

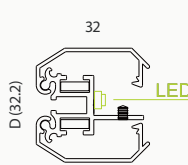
Ref.	Graphic Size	Visual (X-Y)	External (WxHxD)	Tube H	Profile	Packing (QTY)	N.W	G.W	C.B.M	Size (WxHxD)
13.190	A0	815x163	880x1228x32.2	1228		1	10.8kg	13.4kg	0.1050	964x1379x79
13.191	A1	568x815	633x880x32.2	880		1	6.05kg	7.85kg	0.0584	717x1031x79
13.192	A2	394x568	459x633x32.2	633		1	3.5kg	4.6kg	0.0336	543x784x79
13.193	A3	271x394	336x459x32.2	459		1	2.15kg	2.85kg	0.0140	420x610x79
13.194	A4	184x271	249x336x32.2	336		1	1.35kg	1.9kg	0.0128	333x487x79
13.289	500x700	474x673	539x738x32.2	738		1	4.55kg	5.85kg	0.0438	623x890x79
13.290	700x1000	674x974	739x1039x32.2	1039		1	7.95kg	9.95kg	0.0727	790x1165x79

* Other sizes available upon request / Autres dimension sur demande / Outros tamanhos disponíveis sob consulta / Otros tamaños disponibles bajo pedido.

STAND DETAILS



INFORMATION

This multifunction tablet stand provides a Tablet Holder with foam pads for a better grip and a 500x700mm aluminium click frame. Two colors available white or black finish. This holder has an 1700mm aluminium pole with heavy silver steel base. Metal enclosure anti-theft system by 2 keys. Easily rotate 360° the enclosure for displaying portrait or landscape presentation. The tablet cable pass through the pole for a clean look. Request us for 2-sided frame or other Click frame sizes.

DIMENSIONS



TABLET STAND		* W: Width	H: Height	D: Depth	*mm
Packing	QTY	N.W	G.W	C.B.M	Size (WxHxD)
	1	8.2kg	8.5kg	0.0097	440x440x50
	1	2.8kg	3.6kg	0.0123	80x80x1920
	1	1.85kg	2.1kg	0.0026	360x240x30
	1	0.2kg	0.32kg	0.0012	195x110x58
	1	1.3kg	1.7kg	0.0103	760x545x25
	External (WxHxD)		Frame (XxY)		
Product	542x1921x481		500x700		
13.876	<input type="checkbox"/>	For tablet screen: 9.7" or 10.5"			

CLICK FRAME TABLET STAND

new



STAND DETAILS

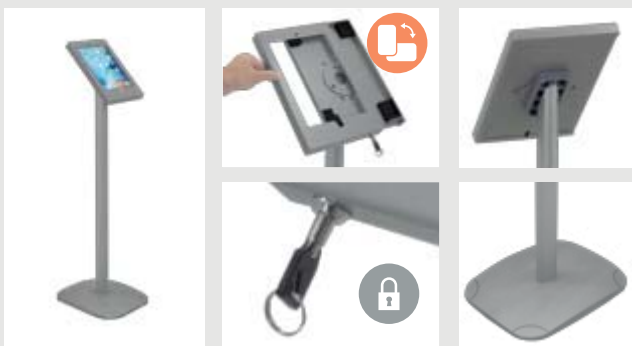

INFORMATION

This Tablet Stand is available in grey color has a metal enclosure anti-theft system and the enclosure rotates easily for portrait or landscape view. Tablet Holder has foam pads for a better grip and to prevent scratches. The tablet cable passes through the pole for a clean look. Cable not included.

DIMENSIONS



TABLET STAND		* W: Width	H: Height	D: Depth	*mm
Packing	QTY	N.W	G.W	C.B.M	Size (WxHxD)
	1	1.65kg	1.76kg	0.0036	388x263x35
	1	0.75kg	0.95kg	0.0047	930x85x60
	1	1.85kg	2.1kg	0.0026	360x240x30
	External (WxHxD)				
Product	303x988x328				express
13.877	<input type="checkbox"/>	For tablet screen: 9.7" or 10.5"			

SLIDING LOCK TABLET STAND

new



* the tablets at this page are not included.

STAND DETAILS



ACCESSORIES INCLUDED





INFORMATION

DIMENSIONS

This modern slim Tablet Stand is constructed on heavy duty metal. White and black color available. It features a metal enclosure anti-theft system. Tablet Holder has foam pads for a better grip and to prevent scratches. The enclosure rotates easily for portrait or landscape presentation. The tablet cable passes through the stand for a clean look. This tablet stand includes the accessories 1 Top banner plate, 2 Top magnetic graphic and 3 Power bank box.



TABLET STAND		* W: Width	H: Height	D: Depth	*mm
	QTY	N.W	G.W	C.B.M	Size (WxHxD)
Packing	1	15kg	16kg	0.0859	310x1260x220
	External (WxHxD)				
Product	340x1280x390				
13.858-1		For 9.7" tablet screen			
13.858-2		For 9.7" tablet screen			

FLOOR METAL TABLET STAND

NEW



* the tablets at this page are not included.



STAND DETAILS



INFORMATION



DIMENSIONS

This modern Console Station is constructed on heavy duty metal. With a metal enclosure anti-theft system. The tablet cable passes through the stand for a clean look. Tablet Holder has foam pads for a better grip and to prevent scratches. Black and white finish available. Request us for optional interchangeable magnetic graphic banner.



TABLET STAND

* W: Width H: Height D: Depth *mm

	QTY	N.W	G.W	C.B.M	Size (WxHxD)
Packing	1	23kg	26.50kg	0.219	1340x430x380
	External (WxHxD)				
Product	360x1260x300				
13.857-1		For tablet screen: 9.7" or 10.5"			
13.857-2		For tablet screen: 9.7" or 10.5"			

CONSOLE STATION TABLET STAND



STAND DETAILS

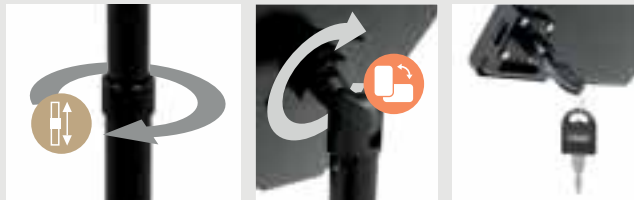

INFORMATION

DIMENSIONS

This black finished Tablet stand is designed for both sitting and standing thanks its telescopic pole. Also, an anti-theft system keeps the technology safely locked. Users may easily rotate 360° or tilt the bracket of the adjustable tablet floor stand for different viewing angles. Tablet Holder has foam pads for a better grip and to prevent scratches. The holder's touchscreen unique design allows access to the home and power buttons while also leaving the auxiliary port open, perfect for credit card readers.

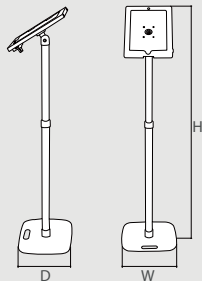

TABLET STAND

* W: Width H: Height D: Depth *mm

	QTY	N.W	G.W	C.B.M	Size (WxHxD)
Packing	1	4kg	4.25kg	0.037	395x760x125
	External (WxHxD)				
Product	245x1350x280				
10.306		For Tablet: ± 242.8x189.7mm			

ADJUSTABLE POLE TABLET STAND



* the tablets at this page are not included.

new

SWAN CLAMP TABLET STAND



STAND DETAILS

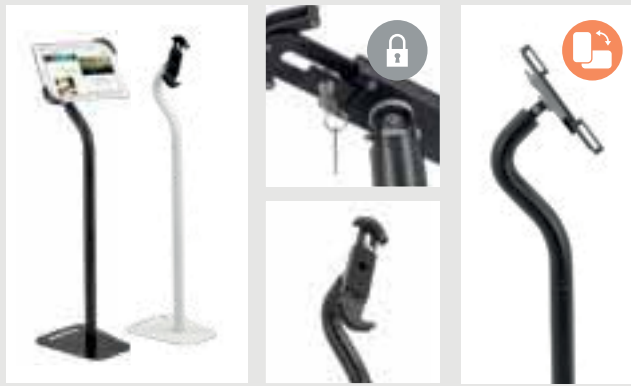

INFORMATION

DIMENSIONS

This swan neck Tablet Stand is available in white or black finish. This holder has an universal enclosure anti-theft system. With Kensington hole for additional security. Easily rotates 360° and tilts the enclosure for displaying in different view angles. The tablet cable passes through the pole for getting a clean look.



TABLET STAND

* W: Width H: Height D: Depth *mm

	QTY	N.W	G.W	C.B.M	Size (WxHxD)
Packing	1	25kg	28kg	0.4838	890x420x110
		External (WxHxD)			
Product		300x190x380			
13.856-1		For Tablets from 7.9" to 10.5"			
13.856-2		For Tablets from 7.9" to 10.5"			



new

FLOOR & DESKTOP TABLET STAND



STAND DETAILS



INFORMATION

DIMENSIONS

This 2-in-1 tablet support is designed for floor or desk use. White or black color. Tablet Holder has foam pads for a better grip and to prevent scratches. With metal enclosure anti-theft system and Kensington hole. Holder easily rotates for portrait or landscape display. The tablet cable passes through the pole for a clean look.



TABLET STAND | DESK

* W: Width H: Height D: Depth *mm

	QTY	N.W	G.W	C.B.M	Size (WxHxD)
Packing	1	28kg	32kg	0.4838	890x420x110
		External (WxHxD)			
Product		300x190x380			
13.855-1		For 9.7" or 10.5" tablets			
13.855-2		For 9.7" or 10.5" tablets			



* the tablets at this page are not included.

NEW

STAND DETAILS

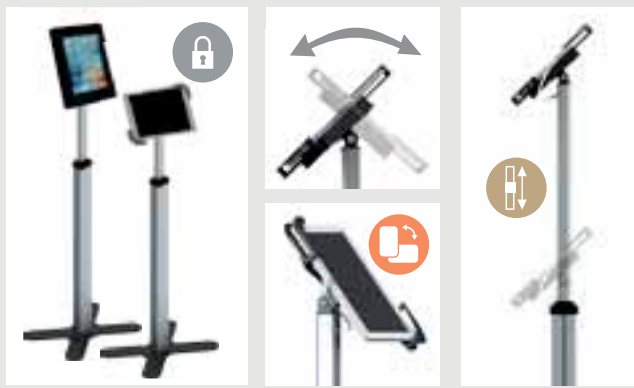

INFORMATION

DIMENSIONS

This tablet floor stand is designed for both sitting and standing use thanks its telescopic pole. In addition, this stand has two available holding systems, universal clamp or metal enclosure. Holder easily rotates 360° and tilts for displaying in different view angles. The tablet cable passes through the pole for a clean look.



TABLET STAND		* W: Width	H: Height	D: Depth	* mm
Packing	QTY: 1	N.W: 1kg	G.W: 1.55kg	C.B.M: 0.006	Size (WxHxD): 365x92x204
	Height (H)				
Product	800-1300				
13.868	Universal clamp for tablets from ± 7.9" to 10.5"				
13.869	Metal enclosure for tablet screen ± 9.7" or 10.5"				

DOUBLE ENCLOSURE TELESCOPIC TABLET STAND



FRAME DISPLAY DETAILS



INFORMATION

* mm

This Tablet Holder is designed for desk or wall mounting. Also, an anti-theft system keeps the technology safely locked. It has foam pads for a better grip and to prevent the scratches. The touchscreen holder's unique design allows access to the home and power buttons while also leaving the auxiliary port open, perfect for credit card readers. The bracket rotates easily 90° for different viewing angles.

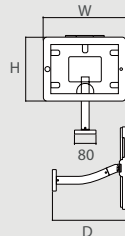

TABLET WALL DESK		* W: Width	H: Height	D: Depth	* mm
Packing	QTY: 1	N.W: 1kg	G.W: 1.55kg	C.B.M: 0.006	Size (WxHxD): 365x92x204
	External (WxHxD)				
Product	248x194x270				
14.108	For Tablet: ± 240x185mm				

METAL FRAME WALL DESK TABLET HOLDER



* the tablets at this page are not included.

new

ACRYLIC FRAME DESK TABLET HOLDER



STAND DETAILS



INFORMATION

DIMENSIONS * mm

Desktop support with Z shape aluminium base and Kensington hole for additional security. Acrylic enclosure locks by 4 screws and rotates for portrait or landscape display. Tablet Holder has foam pads for a better grip and to prevent scratches. Compatible install of Square-Paypal card readers. Black and white colour.

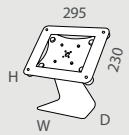

TABLET DESK

* W: Width H: Height D: Depth *mm

	QTY	N.W	G.W	C.B.M	Size (WxHxD)
Packing	1	1.75kg	1.92kg	0.0201	340x200x295
		External (WxHxD)			
Product		210x300x150			
13.851-1		For 9.7" or 10.5" tablets			
13.851-2		For 9.7" or 10.5" tablets			



new

METAL CASE DESK TABLET HOLDER



STAND DETAILS



INFORMATION

DIMENSIONS * mm

Desktop Tablet support with Z shape aluminium base and kensington hole for additional security. Metal enclosure locking with key and rotates for portrait or landscape display. Tablet Holder has foam pads for a better grip and to prevent scratches. Available in black and white.

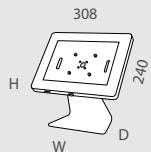

TABLET DESK

* W: Width H: Height D: Depth *mm

	QTY	N.W	G.W	C.B.M	Size (WxHxD)
Packing	1	1.75kg	1.92kg	0.0201	340x200x295
		External (WxHxD)			
Product		210x315x150			
13.852-1		For 9.7" or 10.5" tablets			
13.852-2		For 9.7" or 10.5" tablets			



* the tablets at this page are not included.

new

STAND DETAILS



INFORMATION

DIMENSIONS * mm

Desktop or wall mounting tablet support with full range of movement thanks to its durable metal flexing column. Acrylic enclosure locks by 4 screws and rotates for portrait or landscape display. Compatible install of Square-Paypal card readers. Available in black and white.

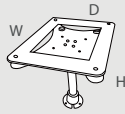

TABLET STAND		* W: Width	H: Height	D: Depth	*mm
	QTY	N.W	G.W	C.B.M	Size (WxHxD)
Packing	1	1.33kg	1.83kg	0.0113	350x280x115
	External (WxHxD)				
Product	295x250x230				
13.853-1		For 9.7" or 10.5" tablets			
13.853-2		For 9.7" or 10.5" tablets			

FLEX ACRYLIC
WALL DESK TABLET HOLDER



STAND DETAILS



INFORMATION

DIMENSIONS * mm

Desktop or wall mounting tablet support with full range of movement thanks to its durable metal flexing column. Metal enclosure locks with key and kensington hole for additional security. Tablet Holder has foam pads for a better grip and to prevent scratches. Available in black and white.

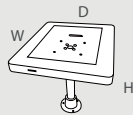

TABLET STAND		* W: Width	H: Height	D: Depth	*mm
	QTY	N.W	G.W	C.B.M	Size (WxHxD)
Packing	1	1.33kg	1.83kg	0.0113	350x280x115
	External (WxHxD)				
Product	310x250x240				
13.854-1		For 9.7" or 10.5" tablets			
13.854-2		For 9.7" or 10.5" tablets			

FLEX METAL
WALL DESK TABLET HOLDER

new



* the tablets at this page are not included.

STAND DETAILS



INFORMATION

*mm

The Sligo Lectern features a double A4-Size reading metallic surface with ring binder. Sligo is ideal for displaying menus at the restaurant entrances, catalogues at retail stores or for presentations at the auditoriums.

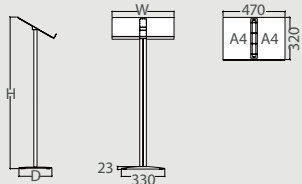

SLIGO METALLIC

* W: Width H: Height D: Depth *mm

	QTY	N.W	G.W	C.B.M	Size (WxHxD)	
Packing	1	4.3kg	4.7kg	0.0107	330x500x65	 x2
	1	1.15kg	1.3kg	0.0028	40x1070x65	
	External (WxHxD)					
Product	470x1147x250					
10.984	Literature Holder: A4 (x2)					

SLIGO METALLIC BINDER



STAND DETAILS



INFORMATION

*mm

The Sligo Lectern features a double A4-Size reading acrylic surface with ring binder. Sligo is ideal for displaying menus at the restaurant entrances, catalogues at retail stores or for presentations at the auditoriums.

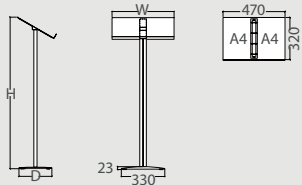

SLIGO ACRYLIC

* W: Width H: Height D: Depth *mm

	QTY	N.W	G.W	C.B.M	Size (WxHxD)	
Packing	1	2.75kg	3kg	0.0107	330x500x65	 x2
	1	1.15kg	1.3kg	0.0028	40x1070x65	
	External (WxHxD)					
Product	470x1147x250					
10.983	Literature Holder: A4 (x2)					

SLIGO ACRYLIC BINDER



STAND DETAILS



DIMENSIONS

REF 13.123

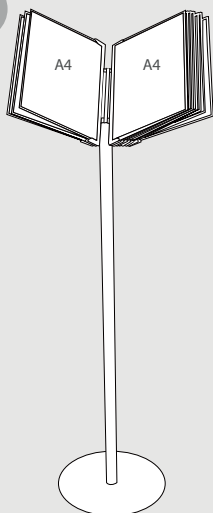

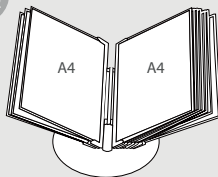

REF 13.122



INFORMATION

This Binder Stands are made of steel, rubber and plastic and includes 10 A4 format plastic sleeves. There are 2 models available: desktop option or with solid and stand base. Ideal for restaurants, coffee stores as menu holder or for trade shows and retail stores for being used as a catalogue display-book.

MENUBOOK 1	QTY	N.W	G.W	C.B.M	SIZE
Packing	1	1.9kg	2.15kg	0.012	340x100x360 mm
13.122	Graphic Size: A4 "Black"			x1	

MENUBOOK 2	QTY	N.W	G.W	C.B.M	SIZE
Packing	1	5.2kg	5.4kg	0.018	345x155x345 mm
13.123	Graphic Size: A4 "Black"			x1	

PLASTIC POCKETS BINDER STAND



HOLDER DETAILS



INFORMATION

* mm

This Display for catalogs is made of 3mm thickness acrylic and features a 4 rings binder. This transparent acrylic Stand can display 2 portrait A4 format documents, so it is an excellent addition to any retail store or personal collection for the exhibition of promotional catalogues.

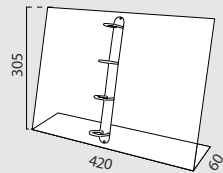

C.DISPLAY	SIZE	THICKNESS	
13.043	A4 + A4	3mm	x2 

ACRYLIC
CATALOGUE HOLDER



STAND DETAILS



INFORMATION

* mm

This Display for catalogs is made of 3mm thickness acrylic and features a 4 rings binder. This transparent Stand can display landscape A4 format documents and it is double-sided, so it is an excellent addition to any retail store or personal collection for the exhibition of promotions.

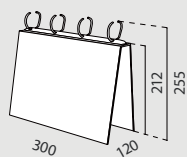

S.DISPLAY	SIZE	THICKNESS	
13.404	A4 + A4	3mm	x2 

ACRYLIC
RING BINDER



STAND DETAILS



INFORMATION

* W: Width H: Height D: Depth * mm

This stylish stand is made of aluminum and acrylic with a metal base that provides greater stability. Features an A5 sandwich graphic holder for an easy graphic change. Also it has a useful 1/3 A4 leaflet dispenser.

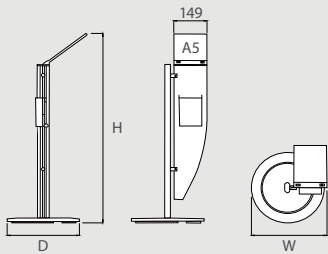

NEILA	SIZE (WxHxD)	GRAPHIC SIZE	LEAFLET
13.675	343x885x330mm	A5	1/3 A4 x1 

NEILA



STAND DETAILS



DIMENSIONS

* mm

This stand is made of 8mm thickness acrylic and features a graphic holder (300x420mm) for displaying relevant information of products. This acrylic stand is great for displaying offers inserting the stand between the mattresses and the base. Ability to fix an A3 Adhesive PVC Pocket ref. 13.064 (sold separately) to exchange the graphics quicker.

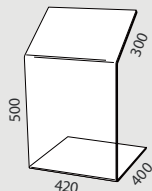

ACRYLIC STAND	SIZE	THICKNESS
50.339	400x420x715mm	8mm x2 

ACRYLIC INFO FLOOR STAND



ALUMINIUM
LECTERN



STAND DETAILS



DIMENSIONS AND OPTIONAL ACCESSORY  *mm

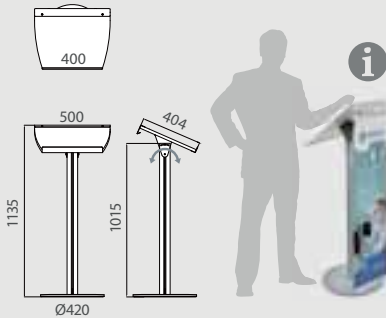

 The back of the surface of this Lectern provides the possibility of attaching an Alulon Poster System (Ref: 10571) to place a banner and customize the look of the lectern. For more information, see Signage chapter.

INFORMATION

This aluminium lectern includes a 19mm thickness white wooden reading surface with a matching aluminum post and circular base offering modern visual displays. The reading surface on this lectern includes a book stop to support your notes during a presentation for award recipients, sheet music for a performance, or a seating chart to assist a hostess, also it features an adjustable angle view for the reading surface. With its sleek contemporary design, this podium is easy to assemble, requiring only a screwdriver and a few minutes. Its silver aluminum pole and base are durable and will last through years of performances and presentations. This stylish yet affordable lectern is a great addition to any presentation space, such as auditoriums, restaurants for menu displays or convention centers to attract the attention of your audience.



Ref: 10571

Alulon Poster System see in Signage chapter (Optional accessory)

ALUMINIUM LECTERN * W: Width H: Height D: Depth *mm

	QTY	N.W	G.W	C.B.M	Size (WxHxD)	
Packing	1	8.2kg	8.5kg	0.0097	440x440x50	 x3
	1	1.59kg	1.75kg	0.0067	80x80x1040	
	1	3.95kg	4.7kg	0.0413	530x445x175	
	External (WxHxD)					
Product	± 500x1135x420					
13.640						

STAND DETAILS



DIMENSIONS AND OPTIONAL ACCESSORY 

*mm

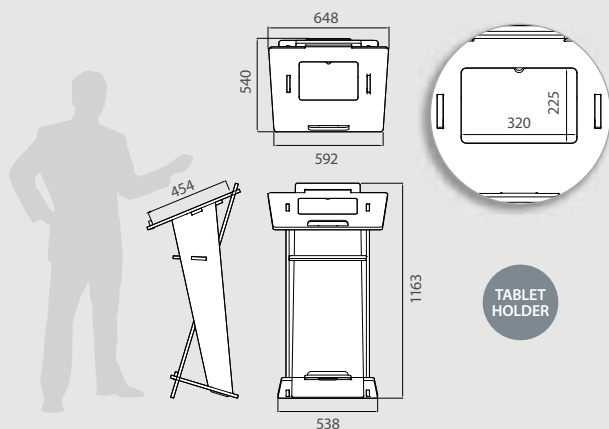

INFORMATION

This stunning wooden lectern does not require the use of any tools for its assembly thanks to its Patent System. Each of its 10 pieces is designed to complete a sturdy and firm structure in very few steps. It is made of 16mm thickness Waterproof MDF Wood with a natural stylish grey finish. It features one shelf in the interior of the lectern, so this way, the extra brochures, business cards and documents can be stored out of sight so your exhibition always appears clean and organized. Also, it features a 318x207mm holder at the top surface for placing securely a tablet. The Fast Wooden Lectern is ideal for being used at auditoriums or convention centers to attract the attention of your audience.

WOODEN LECTERN

*mm

	QTY	N.W	G.W	C.B.M	Size (WxHxD)
Packing	1	19kg	21.41kg	0.0832	605x105x1310
13.641					

REMOVABLE
WOODEN LECTERN



LECTERN SET-UP

10 MANUALLY ATTACHABLE PARTS



* the tablets at this page are not included.

STAND DETAILS



DIMENSIONS

* W: Width H: Height D: Depth * mm

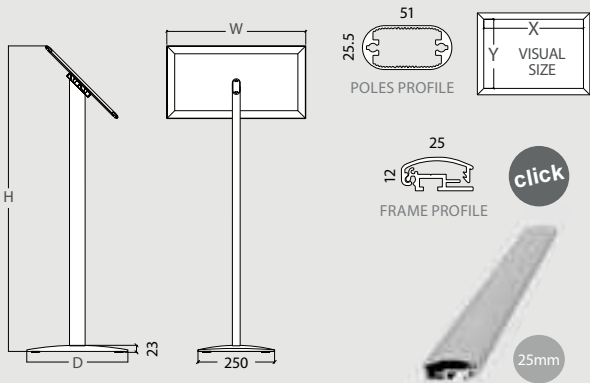



INFORMATION

This Menu Stand features a sturdy aluminium structure with plastic parts. Its Click System frame allows an easy and quick graphic change (anti-reflex cover included). Frames features portrait or a landscape configuration. It is ideal for retail stores, hotel lobbies, restaurant entrances, car dealerships and real states.

ZAFRA



ZAFRA A3	W: Width	H: Height	D: Depth				*mm
	QTY	N.W	G.W	C.B.M	Size (WxHxD)		
Packing	1	0.75kg	0.95kg	0.0047	60x930x85		
	1	1.65kg	1.76kg	0.0034	275x355x35		
	1	0.65kg	0.85kg	0.0061	365x480x35		
	Visual (X-Y)	External (WxHxD)					
Product	400x277	453x998x330					
10.159	Graphic Size: A3						

ZAFRA A4	W: Width	H: Height	D: Depth				*mm
	QTY	N.W	G.W	C.B.M	Size (WxHxD)		
Packing	1	0.75kg	0.95kg	0.0047	60x930x85		
	1	1.65kg	1.76kg	0.0034	275x355x35		
	1	0.45kg	0.55kg	0.0024	270x350x25		
	Visual (X-Y)	External (WxHxD)					
Product	190x278	311x960x330					
10.158	Graphic Size: A4						

STAND DETAILS

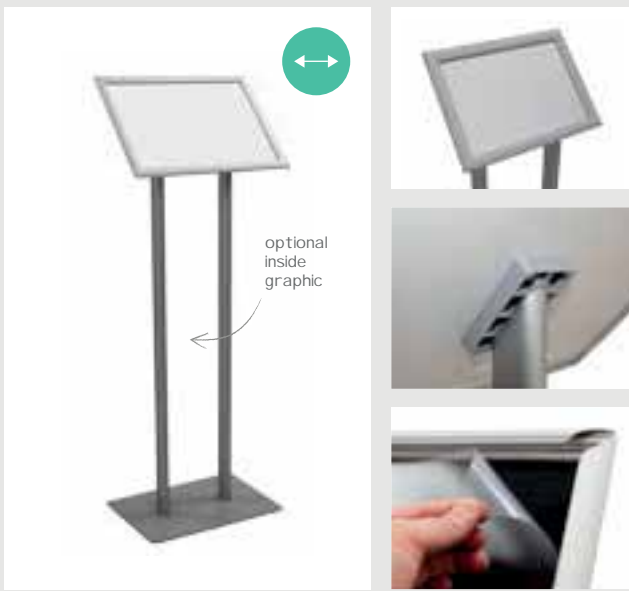

optional inside graphic

DIMENSIONS

* W: Width H: Height D: Depth * mm

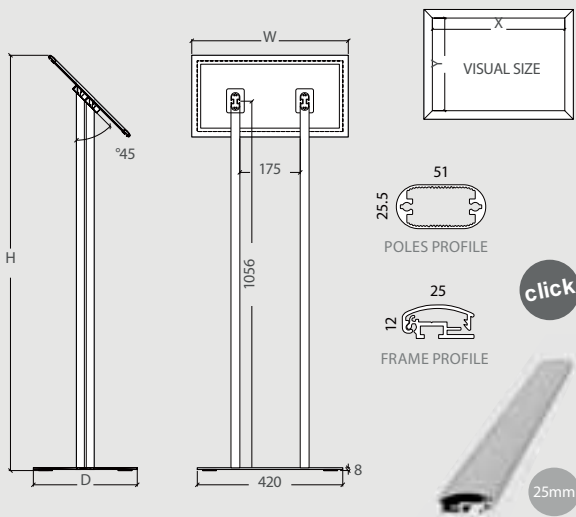

click

INFORMATION

This Ulster Menu Stand is made of aluminium and features an anti-reflex protection cover for its A3 frame. The Ulster frame borders snap open which allows you to insert quickly and easily your printed graphics. Also, it features the option of customize with an inside graphic. It is ideal for hotel lobbies, for restaurant entrances, car dealerships or real states.

ULSTER W: Width H: Height D: Depth * mm

	QTY	N.W	G.W	C.B.M	Size (WxHxD)
Packing	1	2.15kg	2.5kg	0.0102	145x1170x60
	1	5kg	5.3kg	0.0061	365x480x35
	1	0.65kg	0.85kg	0.0061	365x480x35
		Visual (X-Y)	External (WxHxD)		
Product		400x277	452x1200x300		
10.982		Graphic Size: A3			



ULSTER



STAND DETAILS



DIMENSIONS

* W: Width H: Height D: Depth * mm

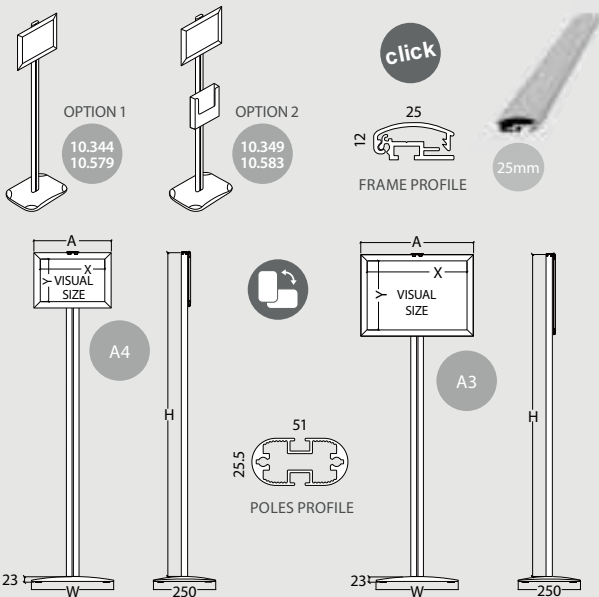

INFORMATION

Melgar 1-sided features a sturdy aluminium structure with plastic parts. Its Click System frame allows an easy and quick graphic change (anti-reflex cover included). Frames allows an easy portrait or a landscape change configuration. Also Melgar is available with an A4 leaflet dispenser. It is ideal for retail stores, hotel lobbies, restaurant entrances, car dealerships and real states.

MELGAR ONE-SIDED



MELGAR A4 1SIDED

W: Width H: Height D: Depth *mm

	QTY	N.W	G.W	C.B.M	Size (WxHxD)	
Packing	1	1.15kg	1.25kg	0.0035	65x1340x40	 x3 
	1	2.8kg	2.93kg	0.0036	263x388x35	
	1	0.82kg	0.91kg	0.0024	350x270x25	
		Visual (X-Y)	External (WxHxA)			
Product		190x278	330x1326x311			
10.344	Graphic Size: A4					

MELGAR A3 1SIDED

W: Width H: Height D: Depth *mm

	QTY	N.W	G.W	C.B.M	Size (WxHxD)	
Packing	1	1.15kg	1.25kg	0.0035	65x1340x40	 x3 
	1	2.8kg	2.93kg	0.0032	263x388x35	
	1	1.44kg	1.74kg	0.0042	475x355x25	
		Visual (X-Y)	External (WxHxA)			
Product		278x401	330x1326x453			
10.579	Graphic Size: A3					



MELGAR A4 1S+DISPENSER

W: Width H: Height D: Depth *mm

	QTY	N.W	G.W	C.B.M	Size (WxHxD)	
Packing	1	1.15kg	1.25kg	0.0035	65x1340x40	 x4 
	1	2.8kg	2.93kg	0.0036	263x388x35	
	1	0.4kg	0.55kg	0.0029	235x250x50	
	1	0.82kg	0.91kg	0.0024	350x270x25	
		Visual (X-Y)	External (WxHxA)			
Product		190x278	330x1326x311			
10.349	Graphic Size: A4		with A4  x1			

MELGAR A3 1S+DISPENSER

W: Width H: Height D: Depth *mm

	QTY	N.W	G.W	C.B.M	Size (WxHxD)	
Packing	1	1.15kg	1.25kg	0.0035	65x1340x40	 x4 
	1	2.8kg	2.93kg	0.0036	263x388x35	
	1	0.4kg	0.55kg	0.0029	235x250x50	
	1	1.44kg	1.74kg	0.0042	475x355x25	
		Visual (X-Y)	External (WxHxA)			
Product		278x401	330x1326x453			
10.583	Graphic Size: A3		with A4  x1			

STAND DETAILS

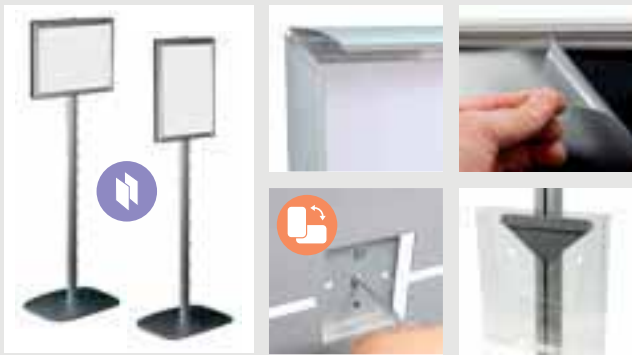

DIMENSIONS

* W: Width H: Height D: Depth * mm

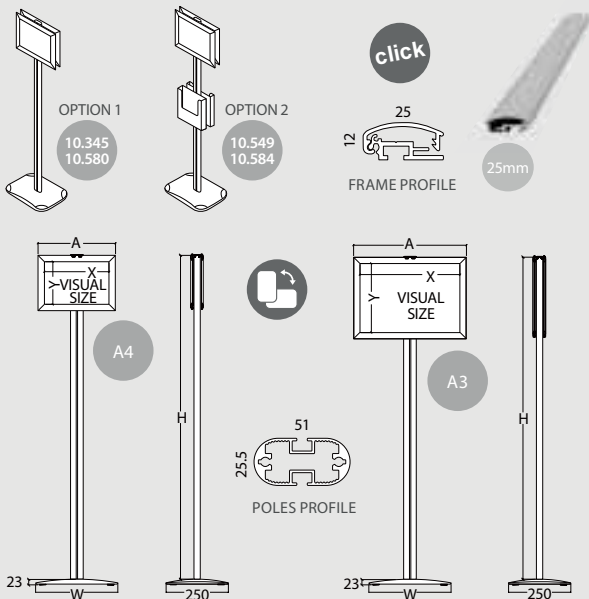

INFORMATION

Melgar 2-sided features a sturdy aluminium structure with plastic parts. Its Click System frame allows an easy and quick graphic change (anti-reflex cover included). Frames allows an easy portrait or a landscape change configuration. Also Melgar is available with an A4 leaflet dispenser. It is ideal for retail stores, hotel lobbies, restaurant entrances, car dealerships and real states.

MELGAR TWO-SIDED



MELGAR A4 2SIDED

W: Width H: Height D: Depth * mm

	QTY	N.W	G.W	C.B.M	Size (WxHxD)	
Packing	1	1.15kg	1.25kg	0.0035	65x1340x40	 x4 
	1	2.8kg	2.93kg	0.0036	263x388x35	
	2	0.82kg	0.91kg	0.0024	350x270x25	
		Visual (X-Y)	External (WxHxA)			
Product		190x278			330x1326x329	
10.345		Graphic Size: A4				

MELGAR A3 2SIDED

W: Width H: Height D: Depth * mm

	QTY	N.W	G.W	C.B.M	Size (WxHxD)	
Packing	1	1.15kg	1.25kg	0.0035	65x1340x40	 x4 
	1	2.8kg	2.93kg	0.0036	263x388x35	
	2	1.44kg	1.74kg	0.0042	475x355x25	
		Visual (X-Y)	External (WxHxA)			
Product		278x401			330x1326x453	
10.580		Graphic Size: A3				

MELGAR A4 2S+2 DISPENSERS

W: Width H: Height D: Depth * mm

	QTY	N.W	G.W	C.B.M	Size (WxHxD)	
Packing	1	1.15kg	1.25kg	0.0035	65x1340x40	 x6 
	1	2.8kg	2.93kg	0.0036	263x388x35	
	2	0.4kg	0.55kg	0.0029	235x250x50	
	2	0.82kg	0.91kg	0.0024	350x270x25	
		Visual (X-Y)	External (WxHxA)			
Product		190x278			330x1326x311	
10.549		Graphic Size: A4			with A4  x2	

MELGAR A3 2S+2 DISPENSERS

W: Width H: Height D: Depth * mm

	QTY	N.W	G.W	C.B.M	Size (WxHxD)	
Packing	1	1.15kg	1.25kg	0.0035	65x1340x40	 x6 
	1	2.8kg	2.93kg	0.0036	263x388x35	
	2	0.4kg	0.55kg	0.0029	235x250x50	
	2	1.44kg	1.74kg	0.0042	475x355x25	
		Visual (X-Y)	External (WxHxA)			
Product		278x401			330x1326x453	
10.584		Graphic Size: A3			with A4  x2	

STAND DETAILS



DIMENSIONS

* W: Width H: Height D: Depth * mm

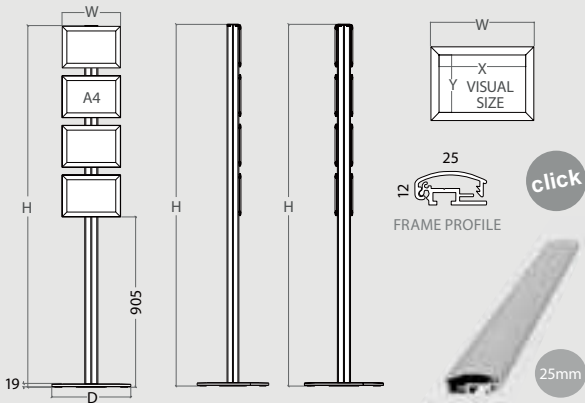

INFORMATION

Info Stands can be used in a variety of locations to showcase eye-catching signage. These stands are made of aluminum with a smooth silver finish and they are equipped with A4 click frames. It features a 8kg weight steel base. If you choose single-sided model you can display 4x A4-sized graphics or 8x A4-sized graphics for double-sided model.

GUADALUPE A4 SINGLE

W: Width H: Height D: Depth * mm

	QTY	N.W	G.W	C.B.M	Size (WxHxD)	
Packing	1	2.8kg	3.6kg	0.0123	80x1920x80	 x6 
	1	8.2kg	8.5kg	0.0097	440x440x50	
	4	0.45kg	0.55kg	0.0024	270x350x25	
Product	Visual (X-Y)		External (WxHxD)			
	190x278		311x1922x Ø420			
10.154	Graphic Size: A4 x 4uni.					

GUADALUPE A4 DOUBLE

W: Width H: Height D: Depth * mm

	QTY	N.W	G.W	C.B.M	Size (WxHxD)	
Packing	1	2.8kg	3.6kg	0.0123	80x1920x80	 x10 
	1	8.2kg	8.5kg	0.0097	440x440x50	
	8	0.45kg	0.55kg	0.0024	270x350x25	
Product	Visual (X-Y)		External (WxHxD)			
	190x278		311x1922x Ø420			
10.156	Graphic Size: A4 x 8uni.					

GUADALUPE A4



STAND DETAILS



DIMENSIONS

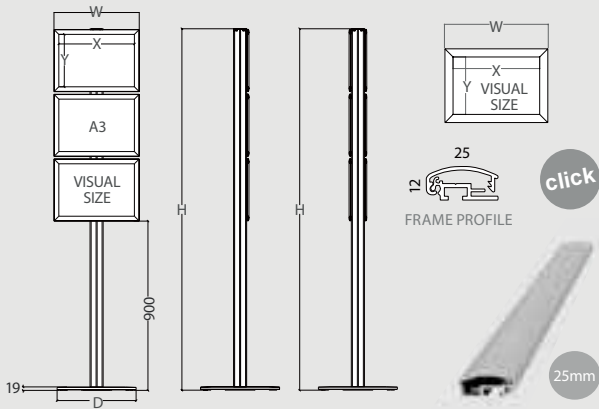

* W: Width H: Height D: Depth * mm



INFORMATION

Sign displays can be used in a variety of indoor locations to showcase eye-catching graphics and signage. These sign displays are equipped with click frames which let you display A3 graphics. If you choose the configuration of single-sided, you can display 3x A3-sized graphics. Also you can create a double-sided presentation by attaching your sign holders back to back and exposing 6x A3-sized graphics. Guadalupe T. These sign displays are made of aluminum and feature a smooth silver finish.

GUADALUPE A3 SINGLE * W: Width H: Height D: Depth * mm

	QTY	N.W	G.W	C.B.M	Size (WxHxD)	
Packing	1	2.8kg	3.6kg	0.0123	80x1920x80	 x5 
	1	8.2kg	8.5kg	0.0097	440x440x50	
	3	0.65kg	0.85kg	0.0061	365x480x35	
		Visual (X-Y)		External (WxHxD)		
Product	278x401	453x1922x Ø420				

10.155 Graphic Size: A3 x 3uni.

GUADALUPE A3 DOUBLE * W: Width H: Height D: Depth * mm

	QTY	N.W	G.W	C.B.M	Size (WxHxD)	
Packing	1	2.8kg	3.6kg	0.0123	80x1920x80	 x8 
	1	8.2kg	8.5kg	0.0097	440x440x50	
	6	0.65kg	0.85kg	0.0061	365x480x35	
		Visual (X-Y)		External (WxHxD)		
Product	278x401	453x1922x Ø420				

10.157 Graphic Size: A3 x 6uni.

GUADALUPE A3



click

STAND DETAILS

SIZES * W: Width H: Height D: Depth * mm

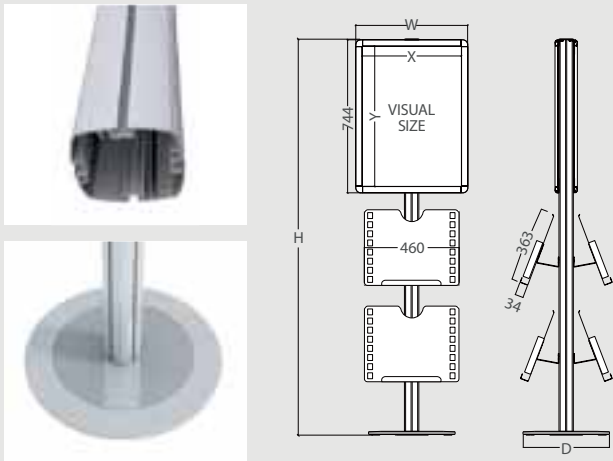

INFORMATION

The Combi Stand consists of an aluminium pole profile, a solid 8kg steel base and multiple possible configurations to choose from, featuring the number of literature holders trays (1-8 units available), the possibility of incorporating one or more upper Click system frames (there are different sizes and also, 2-sided design available). All Combi Stand models are supplied in complete Kits. The Combi Stands are ideal for being used in trade shows, lobby areas, for museums, hotel lobbies, shopping malls, gymnasiums or for the airports.

COMBI STAND

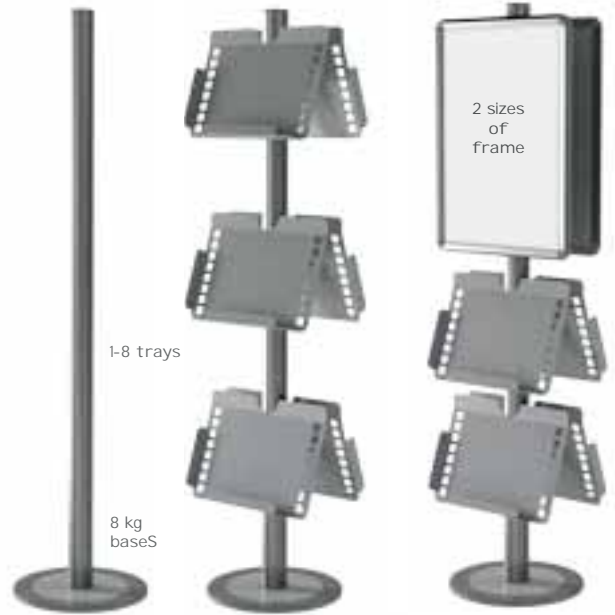

COMBI ONE

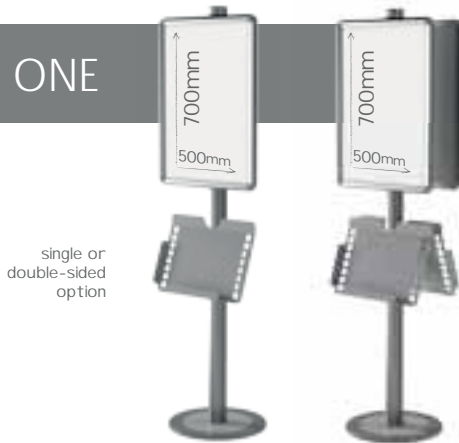

single or double-sided option

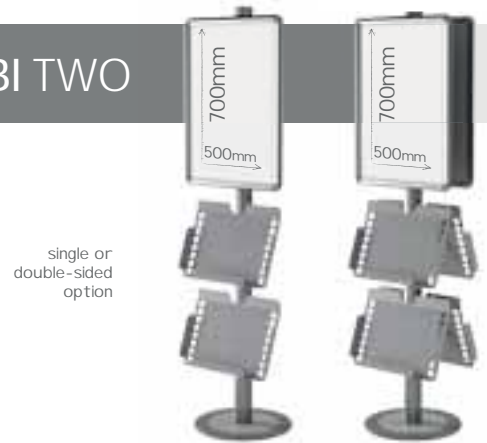

COMBI TWO



single or double-sided option

COMBI ONE 1SIDED

* W: Width H: Height D: Depth *mm



	QTY	N.W	G.W	C.B.M	Size (WxHxD)	
Packing	1	2.8kg	3.6kg	0.0123	80x1920x80	 x4 
	1	8.2kg	8.5kg	0.0097	440x440x50	
	1	1.95kg	2.2kg	0.0089	380x470x50	
	1	1.95kg	2.4kg	0.0104	560x745x25	
Product	Visual (X-Y)		External (WxHxD)			
	481x681		544x1922xØ420			

10.479

Graphic Size: 500x700

COMBI ONE 2SIDED

* W: Width H: Height D: Depth *mm



	QTY	N.W	G.W	C.B.M	Size (WxHxD)	
Packing	1	2.8kg	3.6kg	0.0123	80x1920x80	 x6 
	1	8.2kg	8.5kg	0.0097	440x440x50	
	2	1.95kg	2.2kg	0.0089	380x470x50	
	2	1.95kg	2.4kg	0.0104	560x745x25	
Product	Visual (X-Y)		External (WxHxD)			
	481x681		544x1922xØ420			

10.480

Graphic Size: 500x700 (x2)

COMBI TWO 1SIDED

* W: Width H: Height D: Depth *mm



	QTY	N.W	G.W	C.B.M	Size (WxHxD)	
Packing	1	2.8kg	3.6kg	0.0123	80x1920x80	 x5 
	1	8.2kg	8.5kg	0.0097	440x440x50	
	2	1.95kg	2.2kg	0.0089	380x470x50	
	1	1.95kg	2.4kg	0.0104	560x745x25	
Product	Visual (X-Y)		External (WxHxD)			
	481x681		544x1922xØ420			

10.485

Graphic Size: 500x700

COMBI TWO 2SIDED

* W: Width H: Height D: Depth *mm

	QTY	N.W	G.W	C.B.M	Size (WxHxD)	
Packing	1	2.8kg	3.6kg	0.0123	80x1920x80	 x8 
	1	8.2kg	8.5kg	0.0097	440x440x50	
	4	1.95kg	2.2kg	0.0089	380x470x50	
	2	1.95kg	2.4kg	0.0104	560x745x25	
Product	Visual (X-Y)		External (WxHxD)			
	481x681		544x1922xØ420			

10.486

Graphic Size: 500x700 (x2)

COMBI THREE

single or double-sided option



COMBI THREE 1SIDED		* W: Width	H: Height	D: Depth	*mm
Packing	QTY	N.W	G.W	C.B.M	Size (WxHxD)
	1	2.8kg	3.6kg	0.0123	80x1920x80
	1	8.2kg	8.5kg	0.0097	440x440x50
	3	1.95kg	2.2kg	0.0089	380x470x50
External (WxHxD)					
Product	460x1922xØ420				
10.483					

COMBI THREE 2SIDED		* W: Width	H: Height	D: Depth	*mm
Packing	QTY	N.W	G.W	C.B.M	Size (WxHxD)
	1	2.8kg	3.6kg	0.0123	80x1920x80
	1	8.2kg	8.5kg	0.0097	440x440x50
	6	1.95kg	2.2kg	0.0089	380x470x50
External (WxHxD)					
Product	544x1922xØ420				
10.484					

COMBI FOUR

single or double-sided option



COMBI FOUR 1SIDED		* W: Width	H: Height	D: Depth	*mm
Packing	QTY	N.W	G.W	C.B.M	Size (WxHxD)
	1	2.8kg	3.6kg	0.0123	80x1920x80
	1	8.2kg	8.5kg	0.0097	440x440x50
	4	1.95kg	2.2kg	0.0089	380x470x50
External (WxHxD)					
Product	544x1922xØ420				
10.481					

COMBI FOUR 2SIDED		* W: Width	H: Height	D: Depth	*mm
Packing	QTY	N.W	G.W	C.B.M	Size (WxHxD)
	1	2.8kg	3.6kg	0.0123	80x1920x80
	1	8.2kg	8.5kg	0.0097	440x440x50
	8	1.95kg	2.2kg	0.0089	380x470x50
External (WxHxD)					
Product	544x1922xØ420				
10.482					

COMBI MIX

single or double-sided option



COMBI MIX 1SIDED		* W: Width	H: Height	D: Depth	*mm
Packing	QTY	N.W	G.W	C.B.M	Size (WxHxD)
	1	2.8kg	3.6kg	0.0123	80x1920x80
	1	8.2kg	8.5kg	0.0097	440x440x50
	3	1.95kg	2.2kg	0.0089	380x470x50
	1	1kg	1.2kg	0.0061	365x480x35
Visual (X-Y)		External (WxHxD)			
Product	481x681		544x1922xØ420		
10.487					

COMBI MIX 2SIDED		* W: Width	H: Height	D: Depth	*mm
Packing	QTY	N.W	G.W	C.B.M	Size (WxHxD)
	1	2.8kg	3.6kg	0.0123	80x1920x80
	1	8.2kg	8.5kg	0.0097	440x440x50
	6	1.95kg	2.2kg	0.0089	380x470x50
	2	1kg	1.2kg	0.0061	365x480x35
Visual (X-Y)		External (WxHxD)			
Product	278x402		460x1922xØ420		
10.488					

COMBI FRAME

single or double-sided option

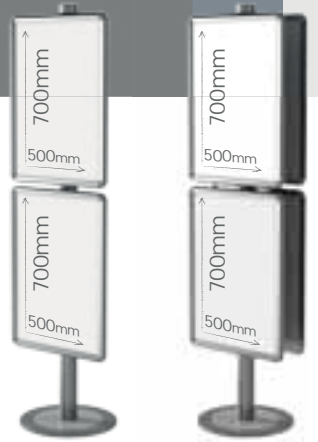

COMBI FRAME 1SIDED		* W: Width	H: Height	D: Depth	*mm
Packing	QTY	N.W	G.W	C.B.M	Size (WxHxD)
	1	2.8kg	3.6kg	0.0123	80x1920x80
	1	8.2kg	8.5kg	0.0097	440x440x50
	2	1.95kg	2.4kg	0.0104	560x745x25
Visual (X-Y)		External (WxHxD)			
Product	481x681		544x1922xØ420		
10.489					

COMBI FRAME 2SIDED		* W: Width	H: Height	D: Depth	*mm
Packing	QTY	N.W	G.W	C.B.M	Size (WxHxD)
	1	2.8kg	3.6kg	0.0123	80x1920x80
	1	8.2kg	8.5kg	0.0097	440x440x50
	4	1.95kg	2.4kg	0.0104	560x745x50
Visual (X-Y)		External (WxHxD)			
Product	481x681		544x1922xØ420		
10.490					

STAND DETAILS



DIMENSIONS

* W: Width H: Height D: Depth * mm

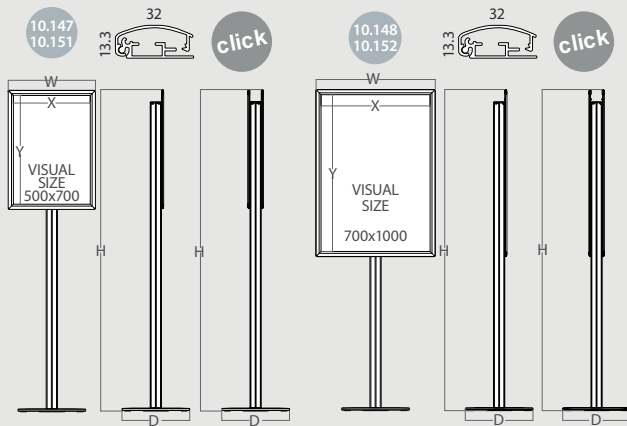

INFORMATION



Sign displays can be used in a variety of indoor locations to showcase eye-catching graphics and signage. It features a 8kg weight steel base and click graphics system frame. Simply flip open the frames' molding and slide your graphics behind the non-glare lenses. These sign displays are made of aluminum and feature a smooth silver finish. Also double-sided presentation is available.

PLASENCIA



PLASENCIA H700

* W: Width H: Height D: Depth * mm

	QTY	N.W	G.W	C.B.M	Size (WxHxD)	
Packing	1	2.8kg	3.6kg	0.0123	80x1920x80	 x3 
	1	8.2kg	8.5kg	0.0097	440x440x50	
	1	1.5kg	2kg	0.0104	560x745x25	
	Visual (X-Y)		External (WxHxD)			
Product	478x678		540x1922x Ø420			
10.147	Graphic Size: 500x700 x 1uni.					

PLASENCIA H1000

* W: Width H: Height D: Depth * mm

	QTY	N.W	G.W	C.B.M	Size (WxHxD)	
Packing	1	2.8kg	3.6kg	0.0123	80x1920x80	 x3 
	1	8.2kg	8.5kg	0.0097	440x440x50	
	1	2.55kg	3.25kg	0.0123	80x1920x80	
	Visual (X-Y)		External (WxHxD)			
Product	678x978		740x1922x Ø420			
10.148	Graphic Size: 700x1000 x 1uni.					

PLASENCIA H700 DOUBLE

* W: Width H: Height D: Depth * mm

	QTY	N.W	G.W	C.B.M	Size (WxHxD)	
Packing	1	2.8kg	3.6kg	0.0123	80x1920x80	 x4 
	1	8.2kg	8.5kg	0.0097	440x440x50	
	2	1.5kg	2kg	0.0104	560x745x25	
	Visual (X-Y)		External (WxHxD)			
Product	478x678		540x1922x Ø420			
10.151	Graphic Size: 500x700 x 2uni.					

PLASENCIA H1000 DOUBLE

* W: Width H: Height D: Depth * mm

	QTY	N.W	G.W	C.B.M	Size (WxHxD)	
Packing	1	2.8kg	3.6kg	0.0123	80x1920x80	 x4 
	1	8.2kg	8.5kg	0.0097	440x440x50	
	2	2.55kg	3.25kg	0.0123	80x1920x80	
	Visual (X-Y)		External (WxHxD)			
Product	678x978		740x1922x Ø420			
10.152	Graphic Size: 700x1000 x 2uni.					

STAND DETAILS



LED

with / without LED light

DIMENSIONS

* W: Width H: Height D: Depth * mm

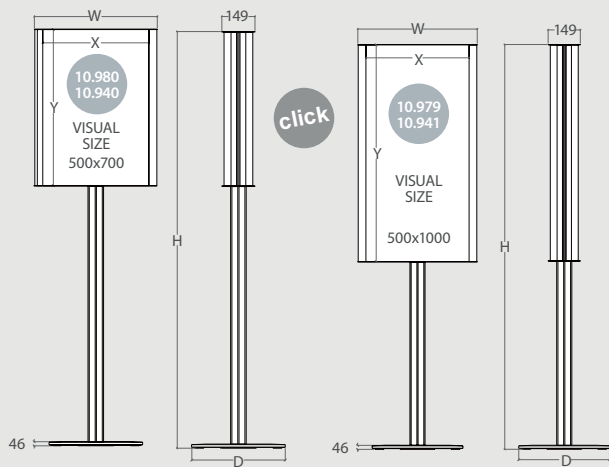

INFORMATION

The Leinster double-sided display is built from sturdy, durable aluminum frame. With an easy-to-use snap frame and edge-lit LED bulbs, Leinster lightbox stand is useful for darker venues, such as halls and movie theaters. The convex holder helps graphics pop out, ensuring that the double sided poster display can be seen from any angle. Designed for day or night time use, Leinster is available without light.

LEINSTER



LEINSTER H700

* W: Width H: Height D: Depth * mm

	QTY	N.W	G.W	C.B.M	Size (WxHxD)	
Packing	1	18.75kg	21.3kg	0.1202	1095x610x180	
	1	8.2kg	8.5kg	0.009	440x440x50	
Product	476x700		552x1868x Ø420			
10.980	Graphic Size: 500x700					

LEINSTER H1000

* W: Width H: Height D: Depth * mm

	QTY	N.W	G.W	C.B.M	Size (WxHxD)	
Packing	1	18.75kg	21.3kg	0.1202	1095x610x180	
	1	8.20kg	8.5kg	0.009	440x440x50	
Product	476x1000		552x1868x Ø420			
10.979	Graphic Size: 500x1000					

LEINSTER H700 LED

* W: Width H: Height D: Depth * mm

	QTY	N.W	G.W	C.B.M	Size (WxHxD)	
Packing	1	18.75kg	21.3kg	0.1202	1095x610x180	 
	1	8.2kg	8.5kg	0.009	440x440x50	
Product	476x700		552x1868x Ø420			
10.940	Graphic Size: 500x700					

LEINSTER H1000 LED

* W: Width H: Height D: Depth * mm

	QTY	N.W	G.W	C.B.M	Size (WxHxD)	
Packing	1	18.75kg	21.3kg	0.1202	1095x610x180	 
	1	8.20kg	8.5kg	0.009	440x440x50	
Product	476x1000		552x1868x Ø420			
10.941	Graphic Size: 500x1000					

TOTEM DETAILS



DIMENSIONS

* W: Width H: Height D: Depth * mm

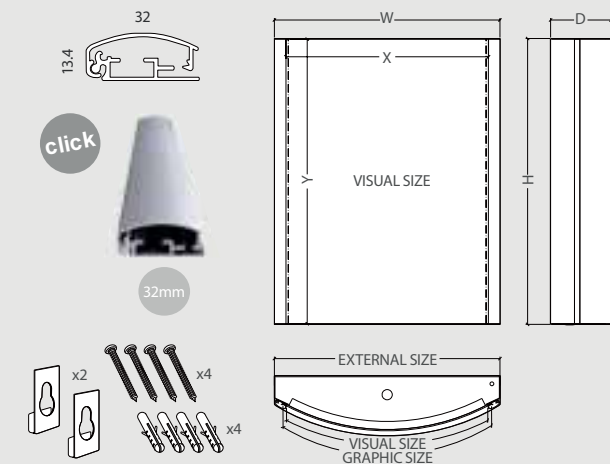

INFORMATION

The Genova Light Wall Totem features a high quality anodized aluminum poster frame along with an accompanying satin metal base. Its Click System allows an easy and quick poster change. The poster holder display, which is a curved sign holder also features backlit LED illumination. Designed for day or night time use, the illuminated lightbox stand has clear PVC lens to prevent glare. Ideal for using at hospitals, clinics, academies, darker halls or movie theaters.

GENOVA
LIGHT TOTEM



GENOVA 700 LED		* W: Width	H: Height	D: Depth	*mm
Packing	QTY: 1	N.W: 9.4kg	G.W: 10.9kg	C.B.M: 0.0918	Size (WxHxD): 600x765x200
	Visual (X-Y)		External (WxHxD)		
Product	518x707		710x560x150		
10.117	Visual: 500x700mm		Graphic Size: 539x707mm		

GENOVA 1000 LED		* W: Width	H: Height	D: Depth	*mm
Packing	QTY: 1	N.W: 15.05kg	G.W: 17.45kg	C.B.M: 0.1758	Size (WxHxD): 805x1065x205
	Visual (X-Y)		External (WxHxD)		
Product	712x1007		760x1010x150		
10.348	Visual: 700x1000mm		Graphic Size: 734x1007mm		



TOTEM DETAILS



OBIDOS LIGHT TOTEM



INFORMATION

* W: Width H: Height D: Depth * mm

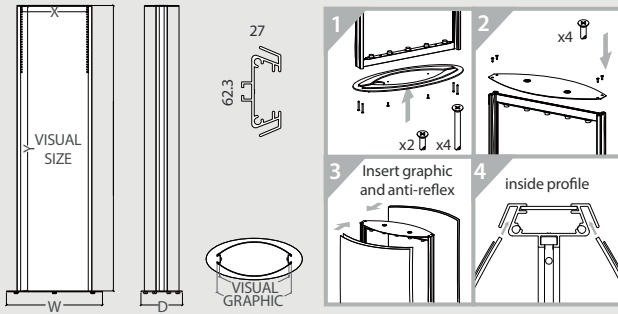

INFORMATION

The Obidos double-sided Totem is built from sturdy, durable silver anodized aluminum with a steel base. Designed with a convex display and bright illumination for day or night use (PVC lens to prevent glare is included). Ideal for restaurants, clinics, academies, darker halls or movie theaters. Anti-reflective plastic included. Obidos is sure to attract the attention of your target audience.

OBIDOS H1600

* W: Width H: Height D: Depth *mm

	QTY	N.W	G.W	C.B.M	Size (WxHxD)	
Packing	1	9.46kg	11.70kg	0.1078	570x1645x115	x2
	1	5.30kg	5.65kg	0.0054	565x275x35	
		Visual (X-Y)	External (WxHxD)			
Product	488x1600	540x1610x234				
10.221	Totem: 500x1600mm		Graphic Size: 516x1600mm			

OBIDOS H1800

* W: Width H: Height D: Depth *mm

	QTY	N.W	G.W	C.B.M	Size (WxHxD)	
Packing	1	13.20kg	16.10kg	0.14	660x1845x115	x2
	1	6.05kg	6.45kg	0.0072	665x310x35	
		Visual (X-Y)	External (WxHxD)			
Product	602x1800	640x1810x277				
10.222	Totem: 600x1800mm		Graphic Size: 630x1800mm			

OBIDOS H2000

* W: Width H: Height D: Depth *mm

	QTY	N.W	G.W	C.B.M	Size (WxHxD)	
Packing	1	16kg	19.40kg	0.1764	750x2045x115	x2
	1	10kg	10.50kg	0.0095	765x355x35	
		Visual (X-Y)	External (WxHxD)			
Product	703x2000	740x2010x320				
10.223	Totem: 700x2000mm		Graphic Size: 731x2000mm			

TOTEM DETAILS



with / without LED

DIMENSIONS

* W: Width H: Height D: Depth * mm

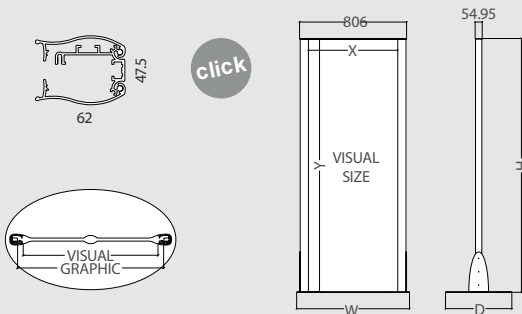

click

The Cascais double-sided Totem is built from sturdy, durable silver anodized aluminum with steel base. Designed for day or night time use, the illuminated lightbox stand has clear PVC lens to prevent glare. This Totem is freestanding and is very well suited as display frame for advertising in retail locations, restaurants, clinics or exhibitions. Anti-reflective plastic included. Cascais lightbox stand is useful for darker halls or movie theaters.

CASCAIS * W: Width H: Height D: Depth *mm

	QTY	N.W	G.W	C.B.M	Size (WxHxD)	
Packing	1	19.25kg	21.9kg	0.1579	850x1955x95	x2
	1	14.85kg	15.75kg	0.0213	875x540x45	
	Visual (X-Y)		External (WxHxD)			
Product	672x1900		850x1910x500			
10.356	Totem: 700x1900mm		Graphic Size: 728x1900mm			

CASCAIS LED * W: Width H: Height D: Depth *mm

	QTY	N.W	G.W	C.B.M	Size (WxHxD)	
Packing	1	20.45kg	23.1kg	0.1579	850x1955x95	x2
	1	14.85kg	15.75kg	0.0213	875x540x45	
	Visual (X-Y)		External (WxHxD)			
Product	672x1900		850x1910x500			
10.354	Totem: 700x1900mm		Graphic Size: 728x1900mm			

CASCAIS LIGHT TOTEM





TOTEM DETAILS

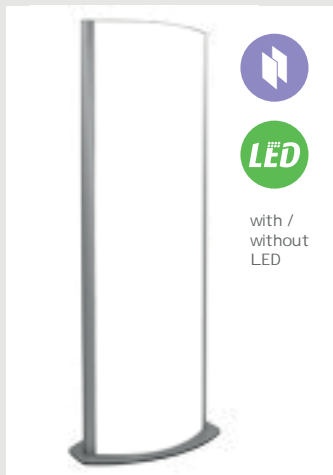

with /
without
LED



INFORMATION

* W: Width H: Height D: Depth * mm

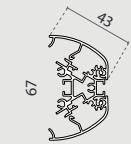

click

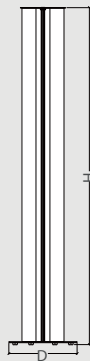
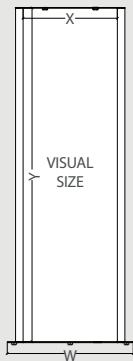
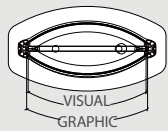

The Nantes Totem is built from sturdy, durable silver anodized aluminum with steel base. Designed for day or night time use (PVC lens included). Anti-reflective plastic included. Ideal for restaurants, clinics, darker halls or movie theaters.

NANTES LIGHT TOTEM



NANTES H1200

* W: Width H: Height D: Depth *mm

	QTY	N.W	G.W	C.B.M	Size (WxHxD)	
Packing	1	8.25kg	10.1kg	0.0816	570x1245x115	
	1	7.65kg	8.65kg	0.0077	620x355x35	
	Visual (X-Y)		External (WxHxD)			
Product	485x1200		600x1217x325			

10.602 Totem: 500x1200mm Graphic: 524x1200mm

NANTES H1600

* W: Width H: Height D: Depth *mm

	QTY	N.W	G.W	C.B.M	Size (WxHxD)	
Packing	1	9.5kg	11.45kg	0.1078	570x1645x115	
	1	7.65kg	8.65kg	0.0077	620x355x35	
	Visual (X-Y)		External (WxHxD)			
Product	485x1600		600x1617x325			

10.436 Totem: 500x1600mm Graphic: 524x1600mm

NANTES H1800

* W: Width H: Height D: Depth *mm

	QTY	N.W	G.W	C.B.M	Size (WxHxD)	
Packing	1	14.6kg	17kg	0.14	660x1845x115	
	1	9.95kg	11.05kg	0.0101	720x400x35	
	Visual (X-Y)		External (WxHxD)			
Product	588x1800		700x1817x370			

10.460 Totem: 600x1800mm Graphic: 626x1800mm

NANTES W700xH1800

* W: Width H: Height D: Depth *mm

	QTY	N.W	G.W	C.B.M	Size (WxHxD)	
Packing	1	15.95kg	18.55kg	0.1570	740x1845x115	
	1	13.4kg	14.55kg	0.0132	820x460x35	
	Visual (X-Y)		External (WxHxD)			
Product	695x1800		800x1817x427			

10.521 Totem: 700x1800mm Graphic: 724x1800mm

NANTES H1200 LED

* W: Width H: Height D: Depth *mm

	QTY	N.W	G.W	C.B.M	Size (WxHxD)	
Packing	1	9.35kg	11.2kg	0.0816	570x1245x115	
	1	7.65kg	8.65kg	0.0077	620x355x35	
	Visual (X-Y)		External (WxHxD)			
Product	485x1200		600x1217x325			

10.402 Totem: 500x1200mm Graphic: 524x1200mm

NANTES H1600 LED

* W: Width H: Height D: Depth *mm

	QTY	N.W	G.W	C.B.M	Size (WxHxD)	
Packing	1	10.5kg	12.45kg	0.1078	570x1645x115	
	1	7.65kg	8.65kg	0.0077	620x355x35	
	Visual (X-Y)		External (WxHxD)			
Product	485x1600		600x1617x325			

10.464 Totem: 500x1600mm Graphic: 524x1600mm

NANTES 1800 LED

* W: Width H: Height D: Depth *mm

	QTY	N.W	G.W	C.B.M	Size (WxHxD)	
Packing	1	15.6kg	18kg	0.14	660x1845x115	
	1	9.95kg	11.05kg	0.0101	720x400x35	
	Visual (X-Y)		External (WxHxD)			
Product	588x1800		700x1817x370			

10.465 Totem: 600x1800mm Graphic: 626x1800mm

NANTES W700xH1800 LED

* W: Width H: Height D: Depth *mm

	QTY	N.W	G.W	C.B.M	Size (WxHxD)	
Packing	1	16.95kg	19.55kg	0.1570	740x1845x115	
	1	13.4kg	14.55kg	0.0132	820x460x35	
	Visual (X-Y)		External (WxHxD)			
Product	695x1800		800x1817x427			

10.556 Totem: 700x1800mm Graphic: 724x1800mm

TOTEM DETAILS



DIMENSIONS

* W: Width H: Height D: Depth * mm

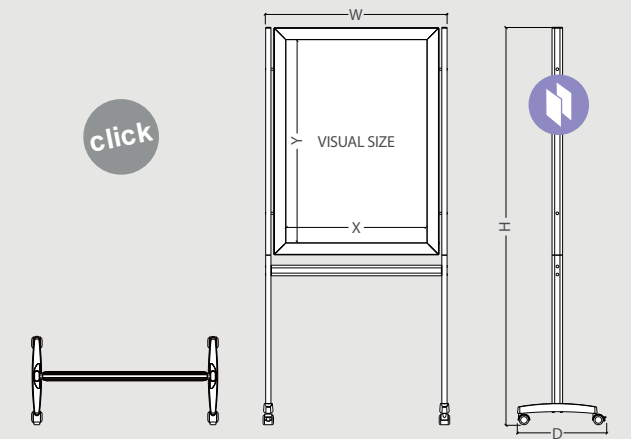

INFORMATION

Designed for day or night time use, Sintra Info Stand is built from sturdy, durable aluminum frame, with a 32mm width Click System profile and edge-lit LED bulbs. Also, it has brake wheels and a resistant antireflection sheet. Ideal for tradeshows, medical clinics, academies, highly-populated lobbies, travel agencies, darker venues, movie theaters, libraries or for waiting rooms.

SINTRA



SINTRA		* W: Width	H: Height	D: Depth	* mm
	QTY	N.W	G.W	C.B.M	Size (WxHxD)
Packing	1	16.5kg	19.95kg	0.01455	920x140x130
	Visual (X-Y)	External (WxHxD)			
Product	683x983	900x1925x430			
10.313	Graphic Size: 700x1000mm				

SINTRA LED LIGHT		* W: Width	H: Height	D: Depth	* mm
	QTY	N.W	G.W	C.B.M	Size (WxHxD)
Packing	1	20.35kg	22.7kg	0.01455	920x140x130
	Visual (X-Y)	External (WxHxD)			
Product	683x983	900x1925x430			
10.767	Graphic Size: 700x1000mm				

TOTEM DETAILS



INFORMATION

* W: Width H: Height D: Depth * mm

Almendralejo Info Stand is designed to be used with brochure advertising. It has a 32mm width profile with click system. Also Resistant antireflection sheet and brake wheels. Ideal for tradeshows, clinics, academies, highly-populated lobbies, travel agencies, libraries or waiting rooms to provide reading material to clients.

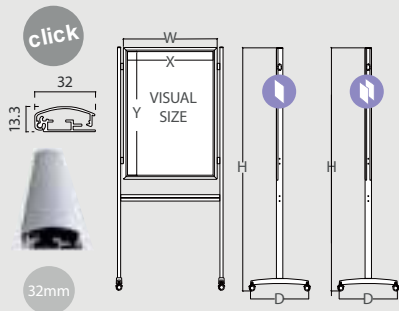

BROCHURE HOLDERS OPTIONS

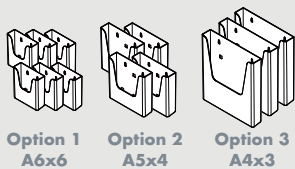

You can choose between 3 options to set-up your brochure holders:

- 6 Brochure Holders A6 size format.
- 4 Brochure Holders A5 size format.
- 3 Brochure Holders A4 size format.

ALMENDRALEJO

* W: Width H: Height D: Depth *mm

	QTY	N.W	G.W	C.B.M	Size (WxHxD)	
Packing	1	8.6kg	10.9kg	0.1258	860x1950x75	
		Visual (X-Y)	External (WxHxD)			
Product	677x977	834x1920x460				
10.160	Graphic Size: 700x1000mm					

ALMENDRALEJO 2-SIDED

* W: Width H: Height D: Depth *mm

	QTY	N.W	G.W	C.B.M	Size (WxHxD)	
Packing	1	10.3kg	13.5kg	0.1258	860x1950x75	
		Visual (X-Y)	External (WxHxD)			
Product	677x977	834x1920x460				
10.759	Graphic Size: 700x1000mm					

ALMENDRALEJO



POLAN



STAND DETAILS



DIMENSIONS * W: Width H: Height D: Depth * mm

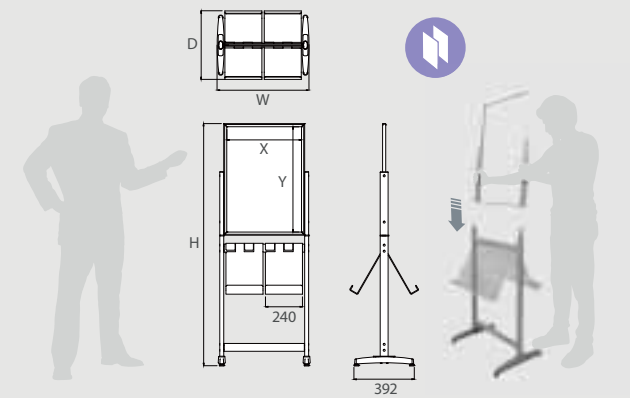

INFORMATION

The Double-sided Polan Info Stand is made of aluminium. There are two available models: without shelves (Ref: 13.862) and with 4 acrylic shelves for 4x A4 format literature documents (Ref: 13.599) like brochures, magazines, or newspapers. Also it features an aluminium frame header at the top. With adjustable leveling feet and an easy glide for the graphic poster (9mm maximum thickness) into the metal grooves of the structure and display it back-to-back.

POLAN WITHOUT SHELVES * W: Width H: Height D: Depth * mm

	QTY	N.W	G.W	C.B.M	Size (WxHxD)
Packing	1	4.41kg	5.67kg	0.0614	880x665x105
		Visual (X-Y)	External (WxHxD)		
Product		485x683	596.5x1569x446		
13.862	Top Header Graphic Size: 500x700mm				



POLAN WITH SHELVES * W: Width H: Height D: Depth * mm

	QTY	N.W	G.W	C.B.M	Size (WxHxD)
Packing	1	6.77kg	8.47kg	0.0614	880x665x105
		Visual (X-Y)	External (WxHxD)		
Product		485x683	596.5x1569x446		
13.599	Top Header Graphic Size: 500x700mm				



4x A4 brochures holders

leveling feet

STAND DETAILS



INFORMATION *mm

Cañada is made of aluminium with 4 acrylic shelves for A4 documents. It features a double-sided large poster holder. Perfect for using in highly populated lobbies, travel agencies, libraries or for waiting rooms to provide reading material to the clients, also thanks to its LED Light, it's ideal for darker halls or movie theaters.

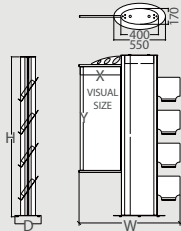

CAÑADA	* W: Width		H: Height	D: Depth	*mm
Packing	QTY	N.W	G.W	C.B.M	Size (WxHxD)
	1	18.5kg	19.7kg	0.3752	652x345x1740
	Visual (X-Y)		External (WxHxD)		
Product	Totem: 308x1699 Totem: 430x1109		1074x1700x280		
10.470	Totem Graphic Size: 324x1700mm Poster Graphic Size: 430x1100mm				

CAÑADA



double sided



4x A4 holders

made of aluminium and acrylic supports

STAND DETAILS



INFORMATION *mm

Hito is made of silver finish aluminium with 3 acrylic shelves for A4 documents. It features a solid and stable 8kg weight steel base and a double-sided large poster holder. Ideal for using in highly populated lobbies, travel agencies, libraries or for waiting rooms to provide reading material to the visiting clients.

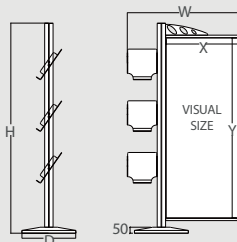

HITO	* W: Width		H: Height	D: Depth	*mm
Packing	QTY	N.W	G.W	C.B.M	Size (WxHxD)
	1	2.8kg	3.6kg	0.0123	80x1920x80
	1	8.2kg	8.5kg	0.0097	440x440x50
	1	1.6kg	1.9kg	0.0190	390x650x75
	Visual (X-Y)		External (WxHxD)		
Product	600x1500		930x1753x450		
10.471	Graphic Size: 600x1510mm				

HITO



3x A4 holders

double faced

8 kg steel base



STAND DETAILS



INFORMATION

*mm

Cañamo has wheels and it is made of aluminium with acrylic shelves. The 1-sided model has 4 shelves for 8xA4 documents and 2-sided: 8 shelves for 16xA4 documents, like brochures, journals or newspapers. Ideal for using in highly-populated lobbies, travel agencies, libraries or waiting rooms to provide literature for clients.

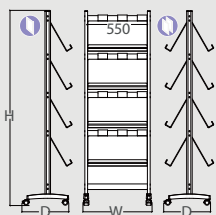

CAÑAMO		* W: Width	H: Height	D: Depth	*mm
	QTY	N.W	G.W	C.B.M	Size (WxHxD)
Packing	1	7.3kg	9kg	0.0487	165x120x410
	1	6.45kg	8.05kg	0.0772	70x1750x630
	External (WxHxD)				
Product	629x1769x487				
10.468	👤	1-Sided (8xA4)			
14.098	👤👤	2-Sided (16xA4)			

CAÑAMO



made of acrylic and aluminium

2 sided available



brake wheels



STAND DETAILS



INFORMATION

*mm

Abad has wheels and it is made of aluminium with acrylic shelves. The 1-sided model has 4 shelves for 8xA4 documents and 2-sided: 8 shelves for 16xA4 documents. Also it has a "Click" frame header at the top. Ideal for using in highly-populated lobbies, travel agencies, libraries or waiting rooms to provide literature for clients.

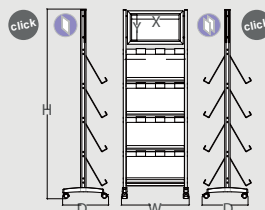

ABAD		* W: Width	H: Height	D: Depth	*mm
	QTY	N.W	G.W	C.B.M	Size (WxHxD)
Packing	1	7.3kg	9kg	0.0487	165x120x410
	1	6.45kg	8.05kg	0.0772	70x1750x630
	Visual (X-Y)	External (WxHxD)			
Product	466x236 629x1769x487				
10.467	👤	Top Header Graphic Size: 488x257mm			
14.099	👤👤	Top Headers Graphic Size: 488x257mm (x2)			

ABAD



- EN With a "Click" aluminium header frame at the top.
- FR Avec un cadre "Click" dans la partie supérieure.
- PT Possui um marco de abertura "Click" na parte superior.
- ES Dispone de un marco "Click" en su parte superior.

2 sided available



brake wheels



LITERATURE STAND Literature Stands

STAND DETAILS



INFORMATION

*mm

Sotillo Stand is made of aluminium with 4 acrylic shelves for 12xA4 documents. It features a "Click" frame header at the top. Also it is equipped with 4 brake wheels. Ideal for using in highly-populated lobbies, travel agencies, libraries or for waiting rooms to provide reading material to the clients.

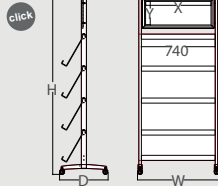

SOTILLO

* W: Width H: Height D: Depth *mm

	QTY	N.W	G.W	C.B.M	Size (WxHxD)	x2
Packing	1	9kg	10.5kg	0.062	410x920x165	
	1	7.35kg	9.35kg	0.101	830x1750x70	
Product	Visual (X-Y)		External (WxHxD)			
	656x236		819x1769x487			
10.469	Graphic Size: 677x257mm					

SOTILLO



- EN With a "Click" aluminium header frame at the top.
- FR Avec un cadre "Click" dans la partie supérieure.
- PT Possui um marco de abertura "Click" na parte superior.
- ES Dispone de un marco "Click" en su parte superior.

for 12xA4 brochures

made of acrylic and aluminium

brake wheels



STAND DETAILS

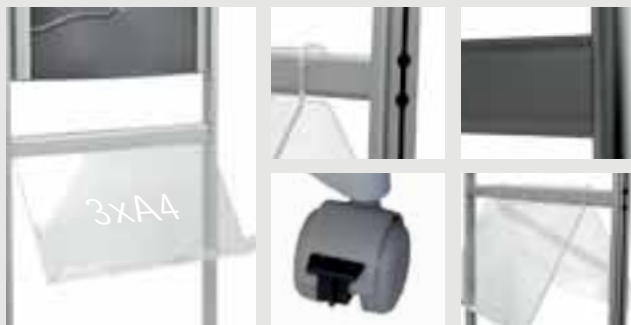

INFORMATION

*mm

Olmedilla is made of aluminium with 1 acrylic shelf for 3xA4 documents. It features a 2-sided "Click" frame board (2 sizes available). Also it has 4 brake wheels. Ideal for using in highly populated lobbies, travel agencies, libraries or for waiting rooms to provide reading material to the clients.

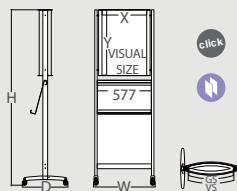

OLMEDILLA H700

* W: Width H: Height D: Depth *mm

	QTY	N.W	G.W	C.B.M	Size (WxHxD)
Packing	1	11.5kg	13.4kg	0.243	1825x205x650
	Visual (X-Y)		External (WxHxD)		
Product	476x696		655x1864x487		
10.472	Top Header Graphic Size: 500x700mm				

OLMEDILLA H1000

* W: Width H: Height D: Depth *mm

	QTY	N.W	G.W	C.B.M	Size (WxHxD)
Packing	1	17kg	18.5kg	0.372	850x1825x240
	Visual (X-Y)		External (WxHxD)		
Product	690x996		856x1864x487		
10.273	Top Header Graphic Size: 700x1000mm				

OLMEDILLA



- EN With a "Click" aluminium header frame at the top.
- FR Avec un cadre "Click" dans la partie supérieure.
- PT Possui um marco de abertura "Click" na parte superior.
- ES Dispone de un marco "Click" en su parte superior.

double sided

made of acrylic and aluminium

brake wheels



STAND DETAILS



INFORMATION

*mm

The Verona Brochure stand is made of aluminium with acrylic shelves and it has 4 shelves for A4 format documents. Also it has a top acrylic header for a 255x147mm graphic. It is ideal for using in highly populated lobbies, at travel agencies, libraries or for waiting rooms to provide reading material to the visiting clients.

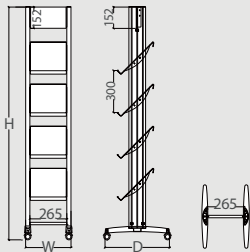

VERONA 4x4

* W: Width H: Height D: Depth *mm

	QTY	N.W	G.W	C.B.M	Size (WxHxD)	
Packing	1	3kg	3.95kg	0.0307	420x430x170	 x2
	1	4.45kg	5kg	0.0118	145x1620x80	
	External (WxHxD)					
Product	325x1660x380					
10.217	Top Header Graphic Size: 255x147mm					

VERONA 4x4



with acrylic header at the top

with 4x4 brochures



brake wheels



STAND DETAILS



INFORMATION

*mm

Verona Stand is made of aluminium with acrylic shelves. This model has 4 shelves for 12 xA4 format documents. Also it has a top acrylic header for a 730x147mm graphic and wheels. Ideal for using in highly-populated lobbies, travel agencies, libraries or for waiting rooms to provide reading material to the visiting clients.

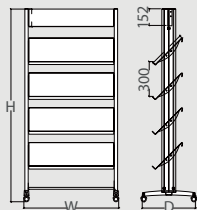

VERONA 12x4

* W: Width H: Height D: Depth *mm

	QTY	N.W	G.W	C.B.M	Size (WxHxD)	
Packing	1	3kg	3.95kg	0.0307	420x430x170	 x2
	1	4.45kg	5kg	0.0188	145x1620x80	
	External (WxHxD)					
Product	800x1660x380					
10.218	Top Header Graphic Size: 730x147mm					

VERONA 12x4



made of acrylic and aluminium

with 12xA4 brochures



brake wheels



STAND DETAILS



DIMENSIONS

* W: Width H: Height D: Depth *mm

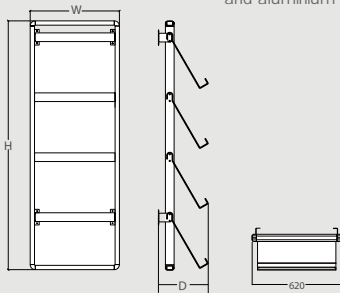

made of acrylic and aluminium

INFORMATION

Athy Brochure Wall Holder has 4 shelves and it is designed to accommodate 2xA4 portrait format documents by shelf. The magazine rack is wall mounting, giving you more floor space while still providing passersby with information. This type of rack system allows you to adjust the literature holders to the size you need. In this manner, it is up and out of your way, while remaining at eye level for your customers. Athy Holder is ideal for an office or lobby. Also see it in waiting rooms to hold your magazines and newspapers, or in information centers, travel bureaus and clinics to hold your brochures.

ATHY * W: Width H: Height D: Depth *mm

	QTY	N.W	G.W	C.B.M	Size (WxHxD)
Packing	1	11.7kg	13.4kg	0.1742	185x1500x650
	External (WxHxD)				
Product	620x1450x290				
10.988					

ATHY



STAND DETAILS



DIMENSIONS

* W: Width H: Height D: Depth * mm

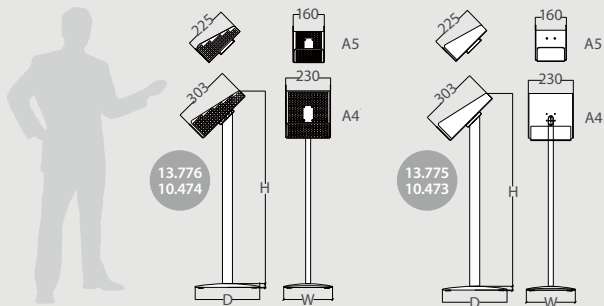

INFORMATION

The Sagres brochure tray stand features acrylic or steel literature holder (depending on model) available for A4 or A5 format documents, an aluminium profile structure with a highly resistant and solid base, which ensures that the unit stays upright in heavily trafficked areas. The silver finish provides a neutral tone that will complement any commercial environment. Ideal for tradeshows, mall stores, exhibitions or places with a high traffic area.

SAGRES METALLIC

* W: Width H: Height D: Depth *mm

	QTY	N.W	G.W	C.B.M	Size (WxHxD)
Packing	1	3.2kg	3.5kg	0.0322	295x120x910
	External (WxHxD)				
Product	± 250x1000x330				
13.776	Brochure Holder Size: A5				
10.474	Brochure Holder Size: A4				

SAGRES ACRYLIC

* W: Width H: Height D: Depth *mm

	QTY	N.W	G.W	C.B.M	Size (WxHxD)
Packing	1	3.1kg	3.4kg	0.0322	295x120x910
	External (WxHxD)				
Product	± 250x1000x330				
13.775	Brochure Holder Size: A5				
10.473	Brochure Holder Size: A4				

SAGRES LECTERN



LITERATURE STAND Literature Stands

STAND DETAILS



DIMENSIONS

* W: Width H: Height D: Depth * mm

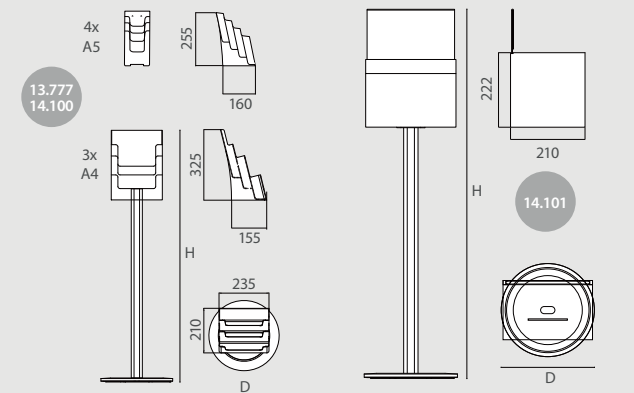

INFORMATION

* W: Width H: Height D: Depth * mm

This Holder Stand features 2 model design: The Brochure Holder has 2 dispenser sizes available: A4 (3 pockets) or A5 format (4 pockets) for displaying documents like brochures, flyers, or catalogues. The BallotBox model is designed for gathering customer feedback, complaints, ideas or contests. Both models has a solid 5kg base with 2 decorative interchangeable extra covers (included). The acrylic brochure holder arrives in a separate box from the base and pole stand. These floorstanding leaflet dispenser are also ideal for special promotions at various events, like tradeshows, hotels information, restaurants, retailers, corporate events or places with a high traffic area.

LEAFLET STAND

* W: Width H: Height D: Depth * mm

	QTY	N.W	G.W	C.B.M	Size (WxHxD)	
Packing	1	5kg	5.3kg	0.0055	350x35x45	x3
	1	0.70kg	0.85kg	0.0035	895x65x37	
	1	1.1kg	1.5kg	0.0194	330x230x260	
External (HxD)						
Product	1170xØ330					
13.777	Leaflet Dispenser Size: A5					
14.100	Leaflet Dispenser Size: A4					

BALLOT BOX

* W: Width H: Height D: Depth * mm

	QTY	N.W	G.W	C.B.M	Size (WxHxD)	
Packing	1	5kg	5.3kg	0.0055	350x350x45	x3
	1	0.70kg	0.85kg	0.0035	895x65x37	
	1	1.7kg	2.4kg	0.0332	380x265x330	
External (HxD)						
Product	1323xØ330					
14.101						

BROCHURE & BALLOTBOX FREESTAND



DISPLAY DETAILS

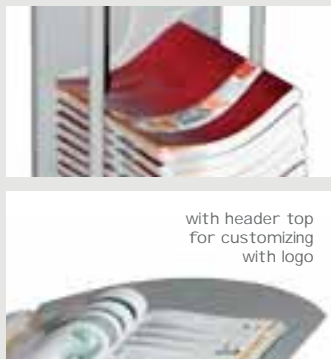

with header top for customizing with logo

INFORMATION

*mm

Bari features a strong and stable design and it is made of steel with a silver finish to easily match any environment. Featuring a top holder for 2xA4 max. wide documents. Perfect for displaying in an orderly manner with an open-front design for customers. Bari is ideal for displaying travel magazines, real estate booklets, autos-for-sale publications, catalogues and other types of literature.

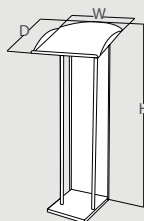

BARI

* W: Width H: Height D: Depth *mm

	QTY	N.W	G.W	C.B.M	Size (WxHxD)
Packing	1	8.6kg	11kg	0.3125	500x1250x500
		External (WxHxD)			
Product	455x1210x450				
10.219					

BARI

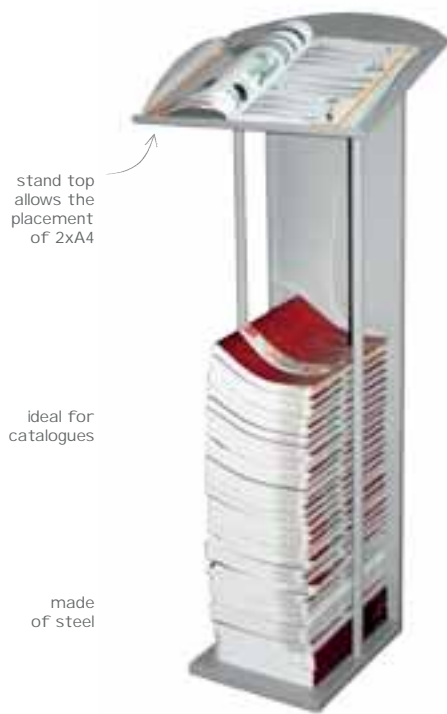

DISPLAY DETAILS

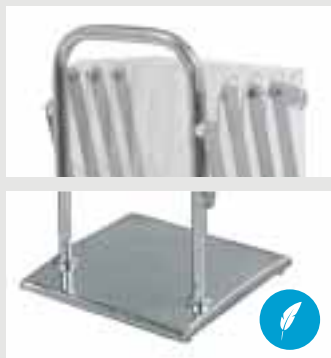

INFORMATION

*mm

Vegas Brochure Stand offers the look and stability of a permanent fixture and the versatility of a portable stand. Featuring 4xA4 format pockets. This foldable silver tradeshow literature rack can be stored with pamphlets and magazines in the pockets, even when the unit is collapsed and stowed away. Set up is simple, just taking the unit out of the carrying bag and pulling the pockets upward. Ideal for conventions, tradeshows, exhibitions, media events or places with a high traffic area.



VEGAS

* W: Width H: Height D: Depth *mm

	QTY	N.W	G.W	C.B.M	Size (WxHxD)
Packing	1	6kg	8kg	0.067	380x470x380
		External (WxHxD)			
Product	280x1605x260				
10.048					

VEGAS



STAND DETAILS



INFORMATION

*mm

Soubran is designed to be mobile and compact. In this model it features 5 portrait steel pockets for A4 portrait format documents. This tradeshow literature rack can be stored with magazines in the pockets, even when the unit is folded and stowed away. With a front bottom space to place a graphic and a carry-bag. Ideal for trade shows, conventions, exhibitions, retail outlets or showroom floors to attract customers looking for additional information.

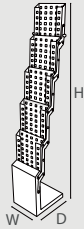

SOUBRAN

* W: Width H: Height D: Depth

*mm

	QTY	N.W	G.W	C.B.M	Size (WxHxD)
Packing	1	8kg	10kg	0.148	550x770x350
		External (WxHxD)			
Product	230x1420x290				
10.416					

SOUBRAN

5x A4 portrait steel shelves

steel structure

the bottom can be used to place a graphic



STAND DETAILS



INFORMATION

*mm

Colmenar is designed to be mobile and compact. In this model it features 5 portrait acrylic pockets for A4 portrait format documents. This tradeshow literature rack can be stored with magazines in the pockets, even when the unit is folded and stowed away. With a front bottom space for graphic and a nylon carry-bag. Ideal for trade shows, conventions, exhibitions, retail outlets or showroom floors to attract customers looking for additional information.

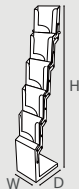

COLMENAR

* W: Width H: Height D: Depth

*mm

	QTY	N.W	G.W	C.B.M	Size (WxHxD)
Packing	1	5kg	7kg	0.148	550x770x350
		External (WxHxD)			
Product	230x1420x290				
13.718					

COLMENAR

5x A4 portrait acrylic shelves

steel structure

the bottom can be used to place a graphic





SAHAGUN

STAND DETAILS



nylon bag
option 13.717

briefcase
option 10.047

DIMENSIONS

* W: Width H: Height D: Depth * mm

option 1
Nylon Bag
13.717

option 2
Briefcase
10.047

13.717

10.047

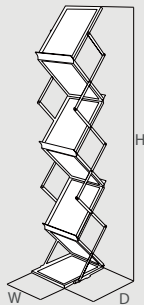

INFORMATION

Sahagun is designed to be mobile and compact. It has a zigzag design that folds down into a small unit. Featuring 5x4 format literature holders for displaying. The literature holders provide a multi-level display system with an unobstructed view of magazines, brochures or any other periodicals you wish to display, also it is very lightweight thanks to its aluminium structure and acrylic holders. This brochure stand folds up into a small, lightweight unit. For a simple transportation you can choose between the nylon carry-bag or the deluxe briefcase option, which has reinforced foam padded. Use this portable literature stand as a single or double sided display at trade shows, retail outlets, or showroom floors to attract customers looking for additional information.

SAHAGUN

* W: Width H: Height D: Depth * mm

	QTY	N.W	G.W	C.B.M	Size (WxHxD)
Packing	1	7.35kg	7.95kg	0.0293	360x480x170
		External (WxHxD)			
Product		260x1490x350			
13.717		Nylon Travel Bag			
10.047		Briefcase			

5x4A4 portrait shelves

stable base by secure system

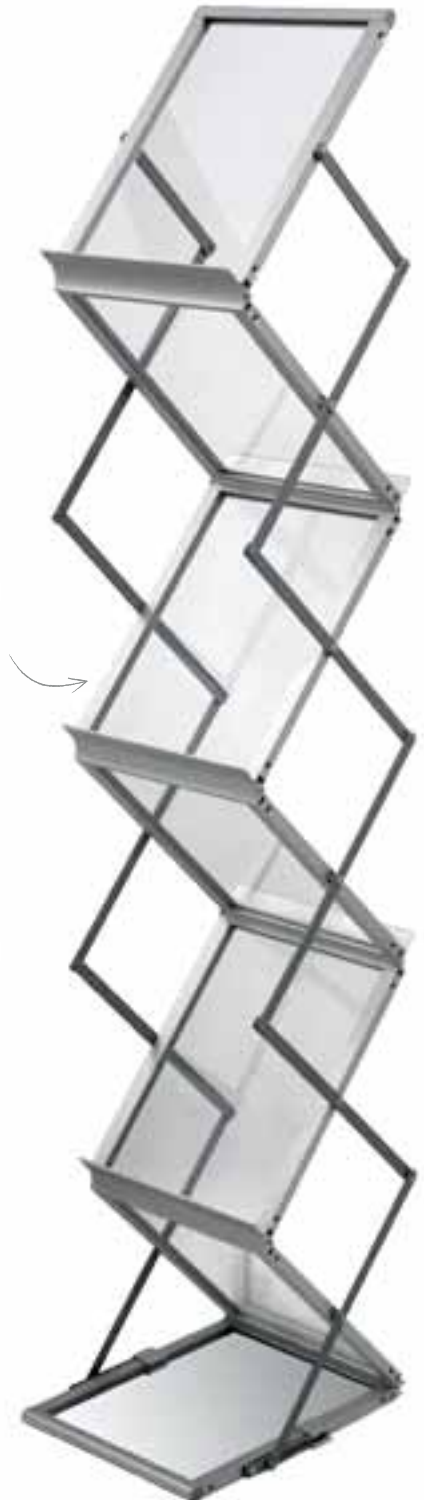

STAND DETAILS



INFORMATION

*mm

The combination of contemporary design, durability and portability make Legnica one of the best options for literature displaying. With front bottom for graphics and 8 pockets for A4 portrait documents. Its design allows you to leave literature inside the pockets when the unit is folded. Ideal for travel magazines, real estate booklets, autos-for-sale publications, business catalogues and also great for libraries, schools, hospitals, tradeshows or showroom floors.

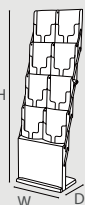

LEGNICA * W: Width H: Height D: Depth *mm

	QTY	N.W	G.W	C.B.M	Size (WxHxD)
Packing	1	14.4kg	15.5kg	0.109	355x570x540
		External (WxHxD)			
Product	480x1560x300				
10.114					

LEGNICA

8x4 portrait pockets



includes carry-bag



STAND DETAILS



INFORMATION

*mm

The Nelas Brochure Stand is made of lightweight and durable wire and it is designed for an easy rotation and quick selection of literature. With 21 pockets for displaying A4 portrait format documents. Featuring 5 swivel castors for an easy and comfortable transport. These displays are great for use at libraries, schools, offices, trade shows, exhibitions, travel agencies, waiting rooms, retail outlets or showroom floors.



NELAS * W: Width H: Height D: Depth *mm

	QTY	N.W	G.W	C.B.M	Size (WxHxD)
Packing	1	8kg	10.05kg	0.203	530x320x1200
		External (WxHxD)			
Product	510x1550x510				
13.101					

NELAS

21x4 portrait pockets

made of steel and plastic parts

easy rotation



STAND DETAILS



INFORMATION

*mm

Mentrida features a stable design with a black finish to easily match any environment. Featuring a top header and a front bottom area for graphics. It also organizes and displays your magazines in an orderly manner with an open-front design for customers. Mentrida Stand features 5 pockets for displaying A4 portrait format documents. Ideal for travel magazines, real estate booklets, autos-for-sale publications, bussiness catalogues and also great for use at libraries, schools, hospitals or doctors' offices.



MENTRIDA

* W: Width H: Height D: Depth

*mm

	QTY	N.W	G.W	C.B.M	Size (WxHxD)
Packing	1	4.2kg	5.1kg	0.0565	120x1520x310
		External (WxHxD)			
Product	250x1465x470				
10.720					

MENTRIDA

5x A4 portrait pockets

made in black painted steel

the bottom can be used to place a graphic



STAND DETAILS



INFORMATION

*mm

Bañeza features a stable design with a black finish to easily match any environment. Featuring a top header and front bottom areas for graphics. Featuring 7 pockets for displaying A4 portrait format documents. Bañeza is ideal for travel magazines, real estate booklets, autos-for-sale publications, bussiness catalogues and also great for use at libraries, schools, hospitals or doctors' offices.



BAÑEZA

* W: Width H: Height D: Depth

*mm

	QTY	N.W	G.W	C.B.M	Size (WxHxD)
Packing	1	2.9kg	3.6kg	0.0532	100x1420x375
		External (WxHxD)			
Product	280x1370x370				
10.044					

BAÑEZA

7x A4 portrait pockets

made in black painted steel

the bottom can be used to place a graphic



STAND DETAILS

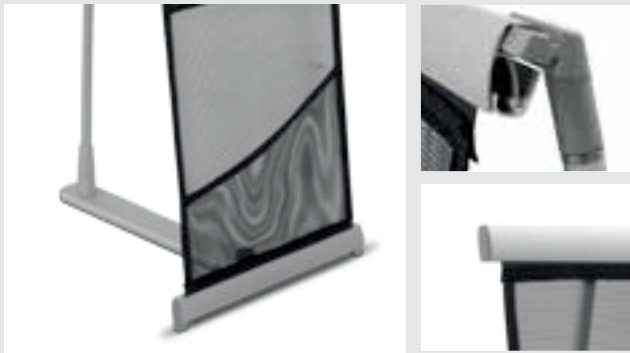

INFORMATION

Sil Brochure Stand is perfect for exhibitors who need a lightweight and portable display for their tradeshow booth. This magazine stand is made of black mesh and has 4 pockets for A4 Portrait format documents. Featuring an elastic design to the pockets that keeps reading materials secure and erect while on display. Includes carrying-bag.

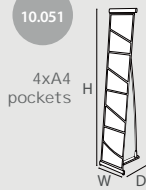

SIL SIMPLE		* W: Width	H: Height	D: Depth	*mm
Packing	QTY	N.W	G.W	C.B.M	Size (WxHxD)
	1	1.05kg	1.20kg	0.0086	120x600x120
	External (WxHxD)				
Product	270x1360x380				
10.051	4 xA4 Pockets				

SIL

4xA4 pockets

made of nylon and aluminium

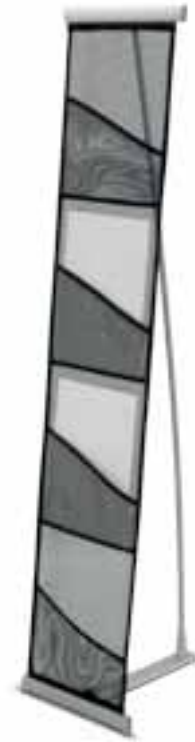

STAND DETAILS



INFORMATION

Sil Double Brochure Stand is perfect for exhibitors who need a lightweight and portable display for their tradeshow booth. This magazine stand is made of black mesh and has 8 pockets for A4 Portrait format documents. Featuring an elastic design to the pockets that keeps reading materials secure and erect while on display. Includes carrying-bag.

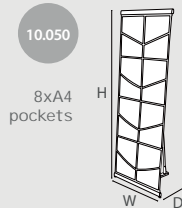

SIL DOUBLE		* W: Width	H: Height	D: Depth	*mm
Packing	QTY	N.W	G.W	C.B.M	Size (WxHxD)
	1	1.4kg	1.55kg	0.0086	120x600x120
	External (WxHxD)				
Product	545x1360x380				
10.050	8 xA4 Pockets				

SIL DOUBLE

8xA4 pockets

made of nylon and aluminium

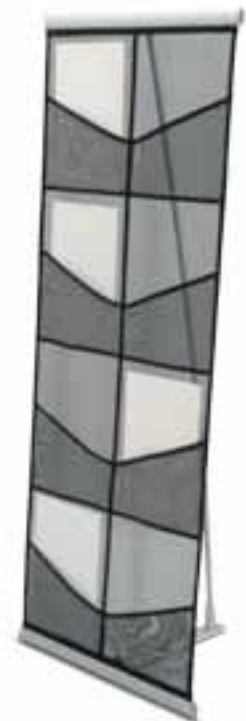

HOLDER DETAILS



DIMENSIONS

* mm

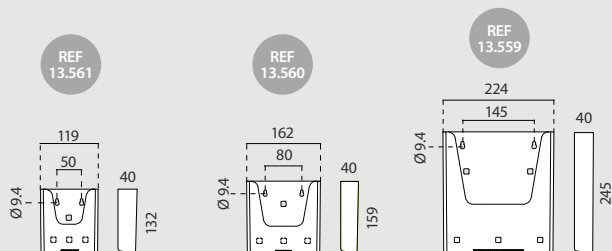

ACCESSORIES COMBINATIONS (NEXT PAGE)



INFORMATION

This acrylic Brochure Holder features 3 sizes: A6, A5 or A4 formats. Built with pre-drilled holes, suitable for being used with suction cups, base feet or for wall mounting with proper accessories (see next page). Rounded pocket fronts give this display a stylish appearance and its acrylic is optically clear.

DISPENSER	COMPARTMENTS	COMPARTMENT SIZE		
13.561	1	A6	x10 	
13.560	1	A5	x10 	
13.559	1	A4	x10 	

SINGLE BROCHURE HOLDER



HANGER DETAILS





INFORMATION

* mm

Acrylic Brochure Holder for A6 leaflet size. Double magnet fixing system. No tools required. Ideal for any Roll Up.



MAGNET DISPENSER	QTY	N.W	G.W	C.B.M	SIZE	
Packing	5	0.85kg	0.95kg	0.004	165x130x215mm	
10.860	Graphic Size: A6				x5 	

MAGNETIC BROCHURE HOLDER



BASE FEET DETAILS

DIMENSIONS

* mm

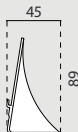

REF 13.499

1 base feet
+ 13.561

2 base feet
+ 13.560

2 base feet
+ 13.559



INFORMATION

Base feet made of acrylic with transparent appearance, they are designed for being used with brochure holders. Possibility of using one or two bases according to holder model. Ideal for making a desktop use. Sold in packs of 20 units.

BASE FEET

SIZE

13.499 45x17x89mm x20 

BASE FEET FOR BROCHURE HOLDER



SUCTION CUPS DETAILS

DIMENSIONS

* mm

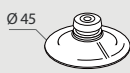

REF 13.559

REF 13.560

REF 13.561

x4

x3

x3

INFORMATION

These Suction Cups give a reinforced adhesion to your brochure holders thanks to their double suction. Possibility of using 3 or 4 suction cups according to holder model. Ideal for making a wall mounted use. Sold in packs of 100 units.

SUCTION CUPS

DIAMETER

12.171 Ø45mm x100 

DOUBLE SUCTION CUP FOR BROCHURE HOLDER



HANGER DETAILS



INFORMATION

DIMENSIONS

* mm

This Hanger is made of metal and it has 3 hooks. It is suitable for being used with leaflet dispensers on shelves. Sold in packs of 10 units.

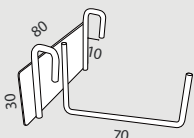

REF 13.406

HANGER

SIZE

13.406 80x30x70mm x10 

SHELF HANGER FOR BROCHURE HOLDER



* Wall holders at this page are available but not included.

HOLDER DETAILS



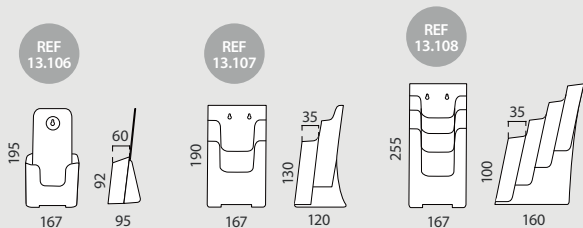

DIMENSIONS

* mm



INFORMATION

This Brochure Holder features an A5 format size and 3 models, depending of its compartments. These literature holders, also known as leaflet displays, pamphlet dispensers, are ideal for distributing your free promotional literature. Built with pre-drilled holes, this literature rack can be wall mounted to ensure that customers will be able to see your promotional material while they browse your gift shop or wait in your lobby. Also, the compact design of this display helps keep your table tops and counters neat and organized. Rounded pocket fronts give this economy display a slightly stylish appearance and its acrylic is optically clear.

1x A5	COMPARTMENTS	COMPARTMENT SIZE		
13.106	1	A5	x4 	
2x A5	COMPARTMENTS	COMPARTMENT SIZE		
13.107	2	A5	x4 	
4x A5	COMPARTMENTS	COMPARTMENT SIZE		
13.108	4	A5	x2 	

TRANSPARENT A5 BROCHURE HOLDER



HOLDER DETAILS



DIMENSIONS

* mm

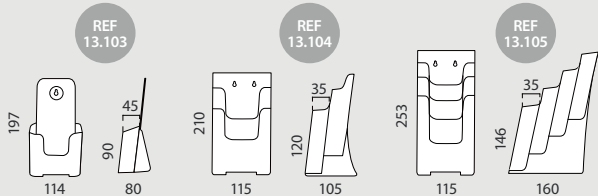

INFORMATION

This Brochure Holder features a 1/3 of A4 format size and 3 models, depending of its compartments. Built with pre-drilled holes, this literature rack can be wall mounted. Compact design and rounded pocket fronts give this economy display a stylish appearance and its acrylic is optically clear.

1x 1/3 A4	COMPARTMENTS	COMPARTMENT SIZE		
13.103	1	1/3 A4	x6	
2x 1/3 A4	COMPARTMENTS	COMPARTMENT SIZE		
13.104	2	1/3 A4	x4	
4x 1/3 A4	COMPARTMENTS	COMPARTMENT SIZE		
13.105	4	1/3 A4	x2	

TRANSPARENT 1/3 A4 BROCHURE HOLDER



HOLDER DETAILS



INFORMATION

This Brochure Holder features a double 1/3 of A4 format. Rounded pocket fronts give this economy display a stylish appearance and its acrylic is optically clear.

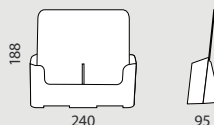

DOUBLE 1/3 A4	COMPARTMENTS	COMPARTMENT SIZE		
13.834	2	1/3 A4	x4	

TRANSPARENT DOUBLE 1/3 A4 BROCHURE HOLDER

NEW



HOLDER DETAILS



DIMENSIONS

* mm

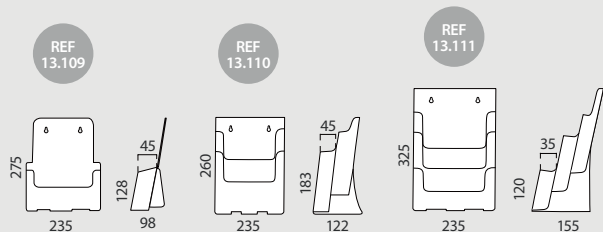

INFORMATION

This Brochure Holder features an A4 format size and 3 models, depending of its compartments. These literature holders, also known as leaflet displays, pamphlet dispensers, are ideal for distributing your free promotional literature. Built with pre-drilled holes, this literature rack can be wall mounted to ensure that customers will be able to see your promotional material while they browse your gift shop or wait in your lobby. Also, the compact design of this display helps keep your table tops and counters neat and organized. Rounded pocket fronts give this economy display a slightly stylish appearance and its acrylic is optically clear.

1x A4	COMPARTMENTS	COMPARTMENT SIZE			
13.109	1	A4	x4		
2x A4	COMPARTMENTS	COMPARTMENT SIZE			
13.110	2	A4	x2		
3x A4	COMPARTMENTS	COMPARTMENT SIZE			
13.111	3	A4	x2		

TRANSPARENT A4 BROCHURE HOLDER



HOLDER DETAILS

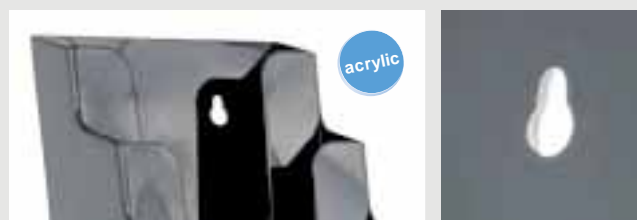

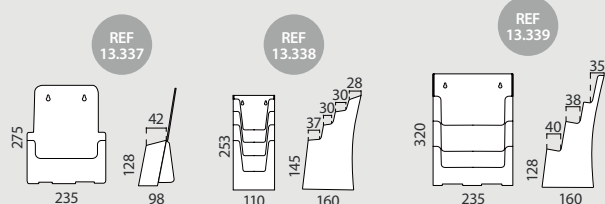

DIMENSIONS

*mm



INFORMATION

These three models of dispensers are made of black colored plastic. Suitable for use them over countertops or mounted on walls. Ideal for being used at retail stores, real estates, offices, hospitals or academies

BLACK	COMPARTMENTS	COMPARTMENT SIZE	
13.337	1	A4	x4 
13.338	4	1/3 A4	x2 
13.339	3	A4	x2 

BLACK BROCHURE HOLDER

countertop or wall
mount unit



HOLDER DETAILS

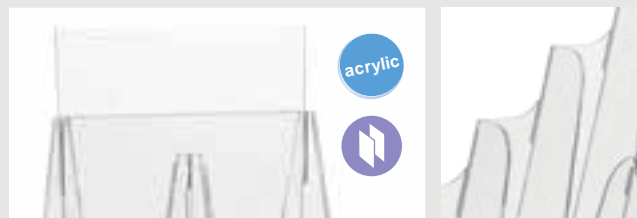

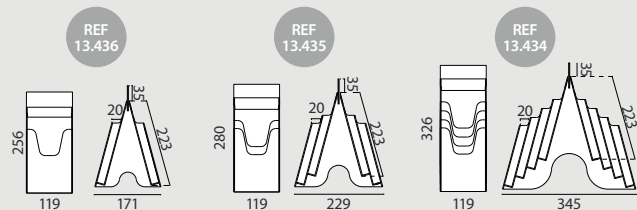

DIMENSIONS

*mm



INFORMATION

These three models of double-sided dispensers are made of transparent plastic. Suitable for use them over countertops. Ideal for being used at retail stores, real estates, offices, hospitals or academies

2-SIDED	COMPARTMENTS	COMPARTMENT SIZE	
13.436	1x2	1/3 A4	x4 
13.435	2x2	1/3 A4	x2 
13.434	4x2	1/3 A4	x2 

2-SIDED 1/3 A4 BROCHURE HOLDER

top advert
insert included

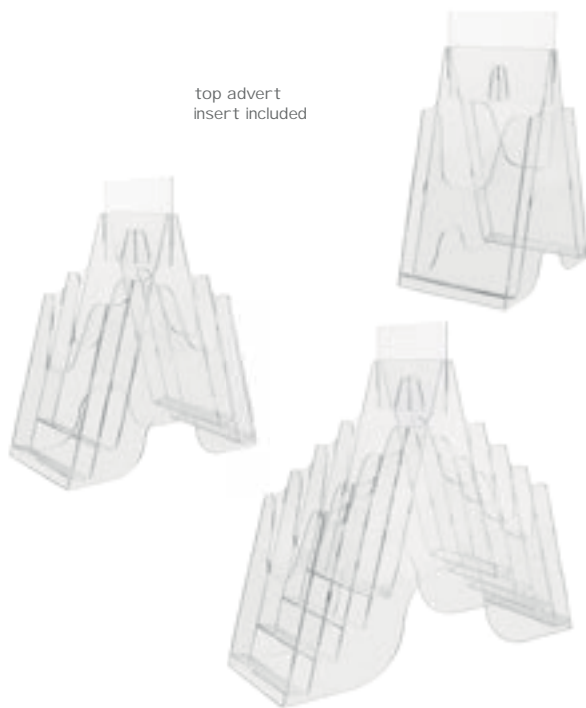

HOLDER DETAILS



INFORMATION

Desktop leaflet dispensers made of chromed wire. Suitable for A4 or 1/3 A4 documents. There are 4 models available. Features rubber feet to protect countertop surface. Ideal for being used at retail stores, offices or hospitals.

WIRE 1/3 A4	QTY	N.W	G.W	C.B.M	SIZE
Packing	1	0.25kg	0.45kg	0.004	135x140x220 mm
13.121	Graphic Size: 1/3 A4			x1	
WIRE 4A	QTY	N.W	G.W	C.B.M	SIZE
Packing	1	0.35kg	0.55kg	0.01	270x150x270 mm
13.117	Graphic Size: 1x A4			x1	
WIRE 4x1/3 A4	QTY	N.W	G.W	C.B.M	SIZE
Packing	1	0.6kg	0.8kg	0.015	270x200x295 mm
13.120	Graphic Size: 4x 1/3 A4			x1	
WIRE 3xA4	QTY	N.W	G.W	C.B.M	SIZE
Packing	1	0.7kg	0.9kg	0.029	270x230x470 mm
13.119	Graphic Size: 3x A4			x1	

WIRE BROCHURE HOLDER



with rubber feet to protect countertop surface



HOLDER DETAILS

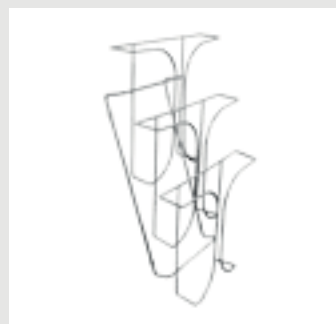

INFORMATION

Wall leaflet dispensers made of chromed wire. Suitable for three A4 documents. Ideal for being used at retail stores, offices or hospitals.

WALL WIRE 3xA4	QTY	N.W	G.W	C.B.M	SIZE
Packing	1	0.65kg	0.85kg	0.027	270x230x450 mm
13.118	Graphic Size: 3x A4			x1	

WALL WIRE BROCHURE HOLDER

wall unit



HOLDER DETAILS



INFORMATION

These Dispensers are made of white or transparent PVC. Suitable for A4, A5 and 1/3 A4 format documents. Ideal for being used on desktops.

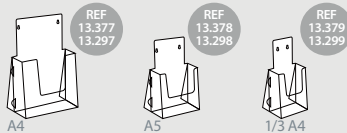

L. CLEAR	COLOR	SIZE	THICKNESS		
13.377		A4	0.7mm	x10	
13.378		A5	0.7mm	x10	
13.379		1/3 A4	0.7mm	x10	
L. WHITE	COLOR	SIZE	THICKNESS		
13.297		A4	0.7mm	x10	
13.298		A5	0.7mm	x10	
13.299		1/3 A4	0.7mm	x10	

PVC BROCHURE HOLDER



HOLDER DETAILS

INFORMATION

*mm



This brochure holder is made of 0.6mm thickness PVC and is suitable for A6 size documents (or for 105mm maximum width documents). It is ideal for desktops.



105x141 A6	DOCUMENT	SIZE	THICKNESS		
13.063	A6	105x141mm	0.6mm	x30	

A6 PVC BROCHURE HOLDER



HOLDER DETAILS

INFORMATION

*mm



Brochure pocket is made of 0.4mm thickness PVC. It is suitable for coupons, calendars or documents with 98mm maximum width. It is ideal for desktops.



PVC POCKET	SIZE	THICKNESS		
13.432	100x135mm	0.4mm	x30	

POCKET PVC BROCHURE HOLDER



HOLDER DETAILS



DIMENSIONS *mm

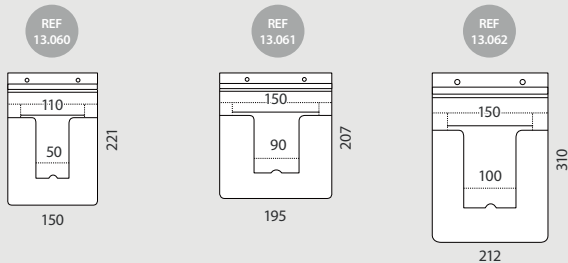

INFORMATION

This dispensers are made of 0.5mm thickness PVC. Suitable for A5 or A6 documents (from 110 to 150mm maximum width documents). They are excellent for fixing on shelf edges thank to its top adhesive strip.

DISPENSER	DOCUMENT	SIZE	THICKNESS	
13.060	A6	150x221mm	0.5mm	x30 
13.061	A5-A6	195x207mm	0.5mm	x30 
13.062	A5	212x310mm	0.5mm	x30 

**SHELF PVC
BROCHURE HOLDER**



HOLDER DETAILS



INFORMATION *mm

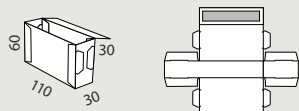

This dispenser, made of PVC with adhesive strip, is excellent for holding business cards or promotional coupons. Container external size: 110x60x30mm.

DISPENSER	SIZE	THICKNESS	
13.431	110x60x30mm	0.4mm	x30 

**COUPON CARD
BROCHURE HOLDER**



HOLDER DETAILS

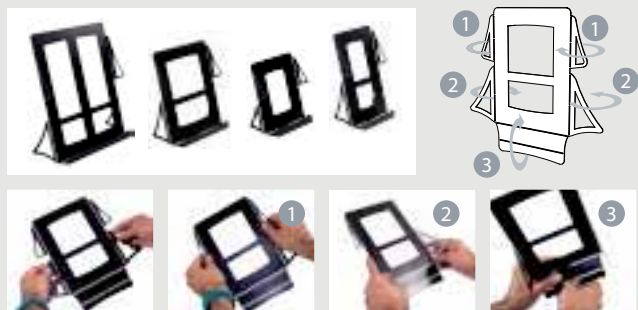

EXTERNAL AND FORMAT SIZES

*mm

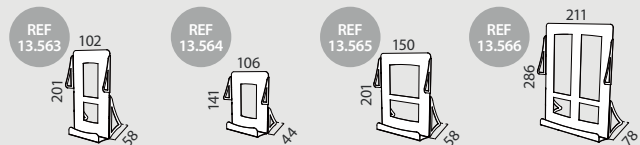

INFORMATION

Black Leaflet Holder made of metal and supplied flat for optimum storage. Featuring 4 sizes (1/3 A4, A6, A5 and A4 format). Quick and simple assembly, in only three steps and folding it with your hands is completely assembled.

METAL H. 1/3 A4	QTY	N.W	G.W	C.B.M	SIZE
Packing	1	0.78kg	0.88kg	0.0009	260x255x16 mm
13.563		Graphic Size: 1/3 A4		x4	
METAL H. A6	QTY	N.W	G.W	C.B.M	SIZE
Packing	1	0.6kg	0.65kg	0.0006	203x195x16 mm
13.564		Graphic Size: A6		x4	
METAL H. A5	QTY	N.W	G.W	C.B.M	SIZE
Packing	1	0.96kg	1.08kg	0.0011	276x255x16 mm
13.565		Graphic Size: A5		x4	
METAL H. A4	QTY	N.W	G.W	C.B.M	SIZE
Packing	1	1.59kg	1.79kg	0.002	375x340x16 mm
13.566		Graphic Size: A4		x4	

HAND FOLDED METAL HOLDER



STAND DETAILS

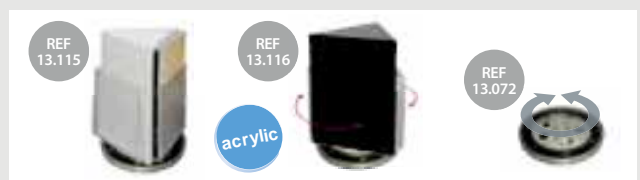

INFORMATION

* mm

This acrylic Rotating Stand is suitable for placing A4 format documents. Offered in black or white color. Also, available the Turntable Display (ref. 13.072).

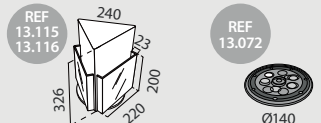

ROTATORY	COLOR	SIZE	
13.115		A4	x1
13.116		A4	x1
TURNTABLE	SIZE		
13.072	Ø140mm	x2	

ROTATORY BROCHURE STAND



HOLDER DETAIL **INFORMATION** **DIMENSIONS** *mm



This transparent Business Card Holder is made of 2mm thickness acrylic. It is ideal for displaying ID cards, directory signage, temporary notes... It is an excellent addition to any desktop. Featuring 3 models available.

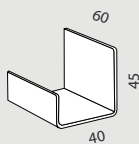

A.HOLDER	SIZE	THICKNESS	
50.321	60x45x40mm	2mm	x20 

BUSINESS CARD ACRYLIC HOLDER



HOLDER DETAIL **DIMENSIONS** *mm

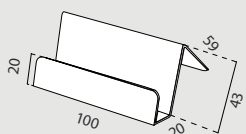

INFORMATION

This grey Business Card Holder is made of 1mm thickness metal. It is ideal for displaying ID cards, directory signage, little notebooks or just for temporary notes... This Card Holder is an excellent addition to any desktop.

METAL HOLDER	SIZE	THICKNESS	
13.413	100x43x20mm	1mm	x10 

BUSINESS CARD METAL HOLDER



HOLDER DETAILS



INFORMATION

This desktop acrylic document tray holder is suitable for A4 format documents. It is made of 4mm thickness acrylic.

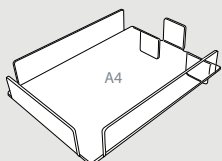

D.D.HOLDER	SIZE	THICKNESS	
13.405	A4	4mm	x2 

DESKTOP DOCUMENT ACRYLIC HOLDER



HOLDER DETAIL



INFORMATION

This Transparent Card Holder is made of 2mm thickness acrylic and it suitable for wall mounting. Thanks to its 6 pockets it is ideal for placing near a reception desk, beside an information point or just next to the entry door, keeping countertops clean and cards highly visible. Each compartment holds approximately 80 cards.

DIMENSIONS *mm

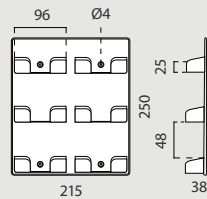

W.M.C.HOLDER	SIZE	THICKNESS	
13.439	250x38x215mm	2mm	x6 

POCKET LANDSCAPE WALL MOUNTED BUSINESS CARD HOLDER



HOLDER DETAILS



INFORMATION

This acrylic Wall Dispenser with portrait orientation has 2 holes at the top for wall mounting. With A4 and A5 format available.

REF 13.382

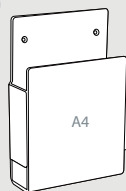

REF 13.383

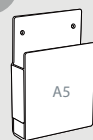

W.D.POCKET	SIZE	THICKNESS	
13.382	A4	4mm	x5 
13.383	A5	4mm	x5 

ACRYLIC POCKET WALL BROCHURE HOLDER





HOLDER DETAILS

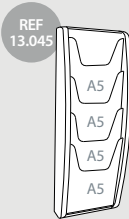
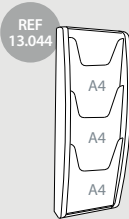

INFORMATION

This wall mount dispenser with portrait orientation white pockets features 2 options: with 3 pockets for A4 size documents or with 4 pockets for A5 size documents. It is ideal for displaying literature documents like flyers, promotions, magazines placed at waiting rooms.



POLYSTIRENE	GRAPHIC SIZE		
13.044	3x A4	x1	
13.045	4x A5	x1	

WALL MOUNTED POLYSTIRENE DISPENSER



HOLDER DETAILS



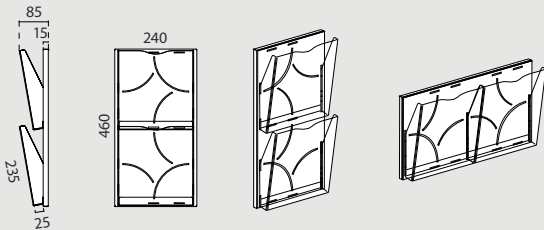

EXTERNAL SIZE

*mm



INFORMATION

This decorative panel for A4 brochures or documents has 2 methacrylate dispensers. Featuring the possibility of installing bolted to the wall vertically or horizontally. It is produced in BLACK RAL 9005 and GREY RAL 9006. It includes 1 black or grey metallic panel, 2 acrylic pockets, screws and hangers.

MULTIPLIX	QTY	N.W	G.W	C.B.M	SIZE	
Packing	1	1.49kg	1.92kg	0.0129	485x265x100mm	
13.374		Pocket Size: A5				x1 

MULTIPLIX WALL POCKET PANEL

black or grey color available



horizontal or vertical orientation available

HOLDER DETAILS



DIMENSIONS

* mm

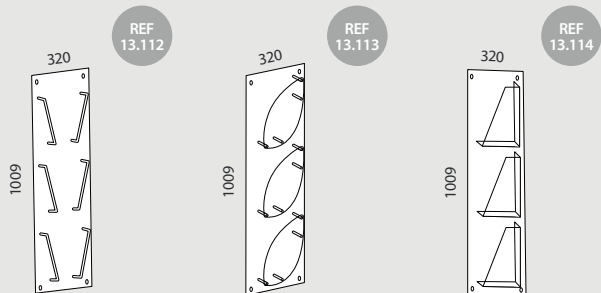

INFORMATION

These Wall Mount Holders are made of plastic, featuring 3 pockets with portrait orientation for A4 size documents. There are available 3 different models according to the shape of their pockets ("line" shaped, "oval" shaped or "straight" shaped pockets). These displays are ideal for displaying literature A4 documents placed at waiting rooms.

A4 LINE SIZE

13.112 320x1009mm x1 

A4 OVAL SIZE

13.113 320x1009mm x1 

A4 FLASH SIZE

13.114 320x1009mm x1 

WALL MOUNTED POLYSTYRENE HOLDER



HOLDER DETAILS



INFORMATION

* mm

This wall leaflet dispenser features a transparent pocket with portrait orientation for A4 size documents. Our display is ideal for displaying literature documents such as flyers, promotions, magazines placed at waiting rooms or offices.

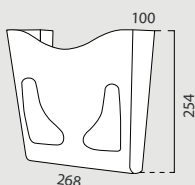

PORTRAIT W.P.	QTY	N.W	G.W	C.B.M	SIZE
Packing	1	0.32kg	0.52kg	0.008	270x270x115 mm
13.126	Size: A4 Portrait		x1 		

**WALL POCKET
LEAFLET DISPENSER**

HOLDER DETAILS



INFORMATION

* mm

This wall leaflet dispenser features a transparent pocket with landscape orientation for A4 size documents. Our display is ideal for displaying literature documents such as flyers, promotions, magazines placed at waiting rooms or offices.

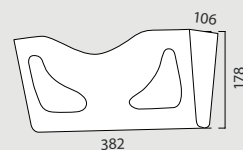

LANDSCAPE W.P.	QTY	N.W	G.W	C.B.M	SIZE
Packing	1	0.3kg	0.5kg	0.009	405x200x115 mm
13.127	Size: A4 Landscape		x1 		

MAILBOX DETAILS



INFORMATION

* mm

This mailbox features a translucent body with portrait orientation and a black cover at the top. Our display is ideal for saving literature documents like flyers, promotions or suggestion forms placed at waiting rooms or offices.

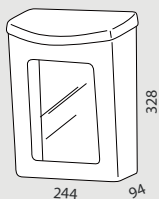

D.MAILBOX	QTY	N.W	G.W	C.B.M	SIZE
Packing	1	0.6kg	0.8kg	0.013	270x350x140 mm
13.125	Size: 244x328x94mm		x1 		

DOCUMENT MAILBOX



BALLOT BOX

214x214x213mm

BALLOT BOX DETAILS



INFORMATION

*mm

This transparent ballot box is made of acrylic (Sides: 5mm thickness, Base, front and cap cover: 3mm thick and Top header: 1.5mm). It features a top landscape header which allows you to display graphic information and an easy change of graphics without having to open the unit. The old image is slid out the side through the openings. Clear entry boxes, acrylic ballot boxes are inexpensive marketing tools with a dual purpose. You can promote your business while creating an interactive display.

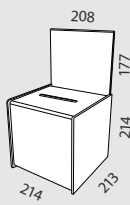

B.B.214x214x213	QTY	N.W	G.W	C.B.M	SIZE
Packing	2	2.266kg	3.116kg	0.041	501x283x289 mm
13.567	Graphic Size: 208x175mm		x2 		

BALLOT BOX

LOCKABLE 224x210x210mm

BALLOT BOX DETAILS

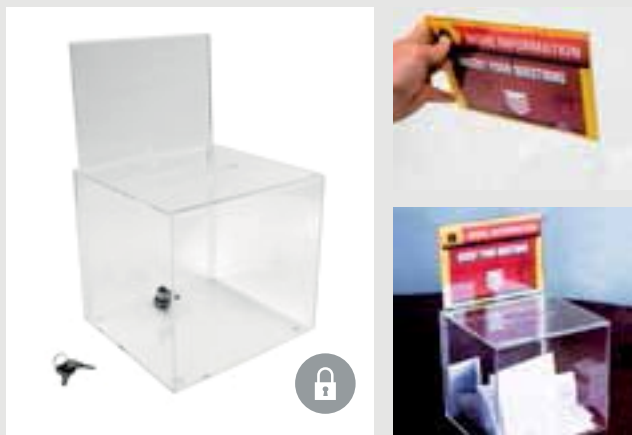

INFORMATION

*mm

This transparent ballot box is made of 3mm thickness acrylic. It features a top A5 landscape header which allows you to display graphic information and an easy change of graphics without having to unlock the unit. The old image is slid out the side through the openings. Also, this acrylic ballot box has a key lock to keep the contents secure and control access. Each unit is shipped with two keys.

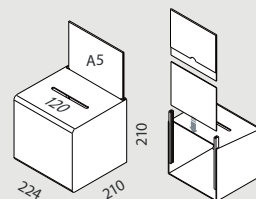

B.B.224x210x210	GRAPHIC SIZE	THICKNESS
13.375	A5	3mm
		x1 

BALLOT BOX DETAILS





INFORMATION

* mm

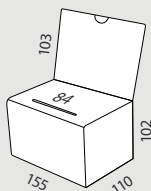
This transparent ballot box is made of acrylic. It features a 150x100mm top landscape header which allows you to display graphic information and an easy change of graphics without having to unlock the unit. The old image is slid out the side through the openings. Also, key lock is available to keep the contents secure and control access.



B.B.150x110x102	QTY	N.W	G.W	C.B.M	SIZE
Packing	1	0.36kg	0.56kg	0.005	175x130x220 mm
13.099	Graphic Size:150x100mm		x2 		

B.B.150x110x102 L	QTY	N.W	G.W	C.B.M	SIZE
Packing	1	0.32kg	0.52kg	0.005	175x130x220 mm
13.100	Graphic Size:150x100mm		x2 		

BALLOT BOX

155x110x102mm



REF 13.100



REF 13.099

BALLOT BOX DETAILS



REF 13.833

INFORMATION

DIMENSIONS

* mm

This ballot boxes are made of 4mm thickness acrylic. Reference 13.833 features a frosted finish. References 13.568 and 13.569 transparent finish. Key lock is available to keep the contents secure and control access.

REF 13.833

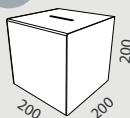

REF 13.568
13.569

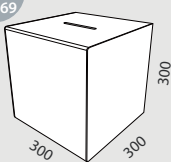

Frosted Ballot Box	QTY	N.W	G.W	C.B.M	SIZE
Packing	1	0.96kg	1.34kg	0.0165	255x250x260 mm
13.833		Size:200x200x200mm			x1 
Ballot Box 300	QTY	N.W	G.W	C.B.M	SIZE
Packing	1	1.88kg	2.738kg	0.0473	360x360x365 mm
13.568		Size:300x300x300mm			x1 
Lock Ballot Box 300	QTY	N.W	G.W	C.B.M	SIZE
Packing	1	1.9kg	2.762kg	0.0473	360x360x365 mm
13.569		Size:300x300x300mm			x1 

SQUARE SIMPLE BALLOT BOX



REF 13.833



Frosted finish

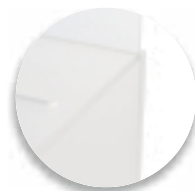

REF 13.568

transparent finish



REF 13.569



BALLOT BOX DETAILS



INFORMATION

* mm

This Smoked ballot box is made of 3mm thickness acrylic. Features a top landscape header to display information. Easy change of graphics without having to unlock the unit through the side openings. Also, these acrylic ballot boxes have a key lock. Each unit is shipped with two keys.

REF 13.570

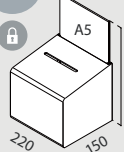

REF 13.571

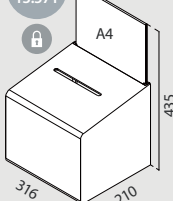

A5 SMOKED	QTY	N.W	G.W	C.B.M	SIZE
Packing	2	1.89kg	2.42kg	0.0298	430x235x295 mm
13.570		Graphic Size: A5 Landscape			x2 
A4 SMOKED	QTY	N.W	G.W	C.B.M	SIZE
Packing	1	3.42kg	4.31kg	0.0587	510x295x390 mm
13.571		Graphic Size: A4 Landscape			x1 

SMOKED ACRYLIC LOCKABLE BALLOT BOX



BALLOT BOX DETAILS



INFORMATION

* mm

This transparent ballot box is made of acrylic. It features a top A4 landscape header which allows you to display graphic information and an easy change of graphics without having to unlock the unit. The old image is slid out the side through the openings. Also, this acrylic ballot box has a key lock to keep the contents secure and control access. Each unit is shipped with two keys.

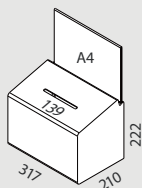

B.B.317x222x210	QTY	N.W	G.W	C.B.M	SIZE
Packing	1	1.7kg	1.9kg	0.022	290x240x330 mm
13.124	Graphic Size:297x210mm		x1 		

BALLOT BOX LOCKABLE 317x222x210mm

ideal for tradeshow, retail stores, malls or supermarkets

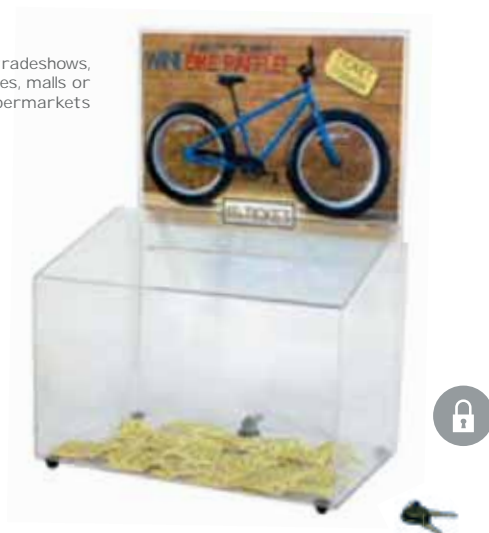

BALLOT BOX DETAILS

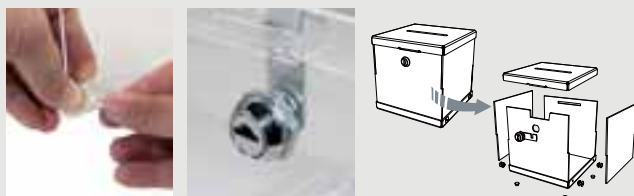

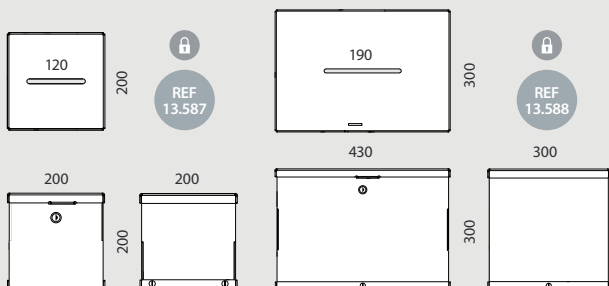

DIMENSIONS

* mm



INFORMATION

This transparent ballot box is made of 4mm thick acrylic. This removable ballot box has a key lock to keep the contents secure and control access. It includes 4 sides, 2 caps, 4 screws, Key lock + 2 Keys. Once removed, all parts are overlaid for an optimum storage. Each unit is shipped with two keys and all the pieces for a correct assembly. Ideal for tradeshow, retails stores, malls or supermarkets.

REMOVABLE 1	QTY	N.W	G.W	C.B.M	SIZE
Packing	1	0.95kg	1.05kg	0.003	265x220x55 mm
13.587	Size: 200x200x200mm		x1 		
REMOVABLE 2	QTY	N.W	G.W	C.B.M	SIZE
Packing	1	2.6kg	2.8kg	0.0083	495x325x55 mm
13.588	Size: 430x300x300mm		x1 		

REMOVABLE BALLOT BOX LOCKABLE 430x300x300mm

fully removable

 REF 13.587

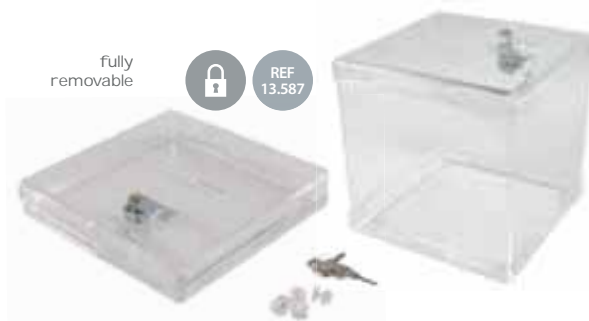

 REF 13.588



ACRYLIC DETAILS

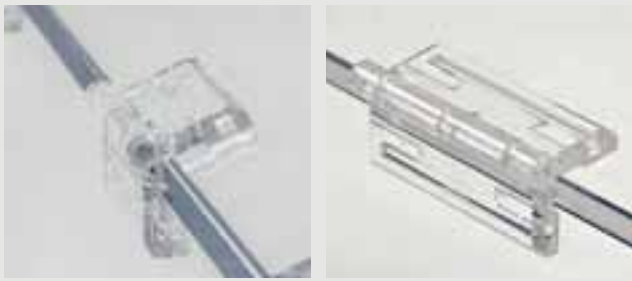

INFORMATION

Acrylic Hinges with 6 available sizes. Ideal for creating acrylic boxes or ballot boxes.



200mm ACRYLIC HINGE

Size

10.943	200mm	x20 
--------	-------	---



65mm ACRYLIC HINGE

Size

10.945	65mm	x20 
--------	------	---



30mm ACRYLIC HINGE

Size

10.947	30mm	x20 
--------	------	---

ACRYLIC HINGE

ACRYLIC DETAILS



100mm ACRYLIC HINGE

Size

10.944	100mm	x20 
--------	-------	---



45mm ACRYLIC HINGE

Size

10.946	45mm	x20 
--------	------	---



25mm ACRYLIC HINGE

Size

10.948	25mm	x20 
--------	------	---

3 PIECES ACRYLIC LOCK

ACRYLIC DETAILS

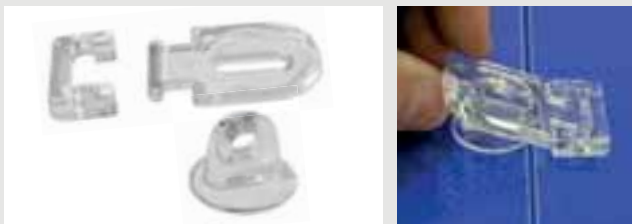

INFORMATION

Acrylic Lock composed by 3 pieces. Ideal for creating acrylic boxes or ballot boxes.

A LOCK

Pieces

10.949	3 pieces	x20 
--------	----------	---

ACRYLIC HANGER

ACRYLIC DETAILS

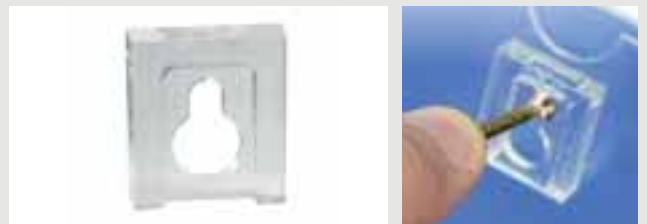

INFORMATION

Acrylic Hanger. Ideal for holding acrylic stands, boxes or ballot boxes.

A HANGER

Size

10.950	22x25mm	x20 
--------	---------	---